



VINCENT  
SHEPPARD

outdoor  
collection  
2024

## **Finding comfort**

Vincent Sheppard has been designing and manufacturing indoor and outdoor furniture with exceptional seating comfort since 1992. The company is worldwide market leader in Lloyd Loom furniture, a technique where kraft paper is twisted around a metal wire and woven into unique furniture pieces.

By constantly challenging itself and its design aesthetics, Vincent Sheppard is able to present young, contemporary furniture collections that answer to all modern needs. We combine a clear focus on quality and comfort with craftsmanship and an age-old technique, and translate these ingredients into qualitative, durable and appealing designs. With a wide variety of indoor as well as outdoor pieces of high quality, Vincent Sheppard is a favourite of many interior aficionados.

**The Vincent Sheppard team**

# INDEX

## COLLECTIONS

ANTON	11	MAX	108
BISTRO TABLES	108	MAYA	92
CLEO	46	MIA	153
CLIFF	74	MONA	54
DAVID	76	MORA	92
EDGARD	120	NOA	54
FREYA	54	ODA	12
FRIDA	4	OLAF	109
GIPSY	120	OTTO	169
IVO	132   154	REMI	54
KENZO	153	ROXANNE	109
KODO	20	ROXY	109
LENA	120	ROY	102
LENTO	38	ROZY	111
LEO	64	SAFI	144
LIGHT MY TABLE	92	SAM	11
LILO	53	TIKA	92
LOOP	84	TOUNDRA	74
LLOYD LOOM	156	VOLTA	54
LUCY	134	WICKED	112
MATTEO	130		

DECO CUSHIONS	168
---------------	-----

TECHNICAL INFORMATION	171
-----------------------	-----

FABRICS	174
---------	-----

PRODUCT OVERVIEW	177
------------------	-----

# FRIDA

A distinctive design with a spacious back, round frame and tactile seat.  
Beautiful from all sides and angles.

LOUNGE CHAIR - DINING CHAIR









FRIDA LOUNGE CHAIR anthracite  
ANTON COFFEE TABLE









FRIDA DINING CHAIR anthracite





FRIDA DINING CHAIR anthracite  
SAM DINING TABLE





FRIDA DINING CHAIR dune white  
NOA DINING TABLE



## FRIDA LOUNGE CHAIR

### MATERIALS

untreated teak or black stained brushed teak  
polypropylene rope

### COLOUR

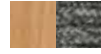

UNTREATED TEAK  
ANTHRACITE ROPE



UNTREATED TEAK  
DUNE WHITE ROPE



BRUSHED TEAK BLACK  
ONYX BLACK ROPE

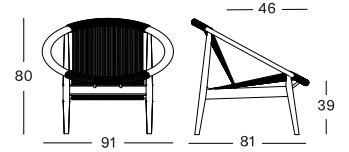

## FRIDA DINING CHAIR

### MATERIALS

untreated teak  
polypropylene rope

### COLOUR

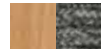

UNTREATED TEAK  
ANTHRACITE ROPE



UNTREATED TEAK  
DUNE WHITE ROPE

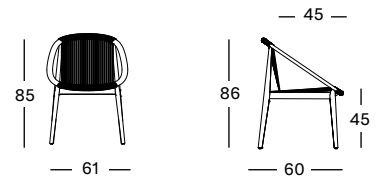

## ANTON SIDE & COFFEE TABLE TEAK

### MATERIALS

untreated teak

### DIMENSIONS

- 40,5 cm H x Ø 40 cm
- 34,5 cm H x Ø 70 cm

### COLOUR



UNTREATED TEAK

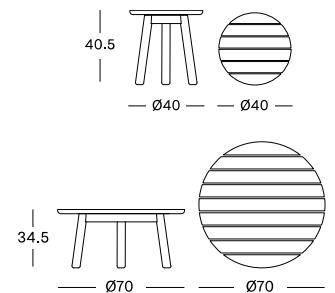

## SAM DINING TABLE

### MATERIALS

untreated solid teak

### DIMENSIONS

75 cm H x Ø 120 cm

### COLOUR



UNTREATED TEAK

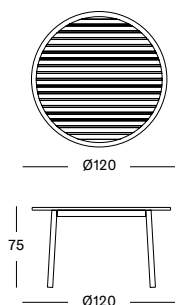

# ODA

Warm teak, textured straps and pillow-like cushions create an ambiance that is both playful and inviting.

LOUNGE CHAIR - LOUNGE SOFA 2,5S - LOUNGE SOFA 3S - SIDE TABLE - COFFEE TABLE









ODA LOUNGE CHAIRS AND LOUNGE SOFA 2,5S  
ODA COFFEE TABLE ceramic portland









LEFT PAGE: ODA COFFEE TABLES ceramic portland  
RIGHT PAGE: ODA LOUNGE CHAIR





## ODA LOUNGE CHAIR

### MATERIALS

untreated teak  
polypropylene straps

### CUSHION

seat 14 cm quick dry foam  
back polyester fibre filling

### COLOURS



UNTREATED TEAK  
FLAX STRAP

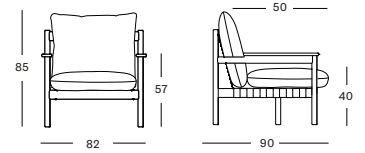

## ODA LOUNGE SOFA 2,5S

### MATERIALS

untreated teak  
polypropylene straps

### CUSHIONS

seat 14 cm quick dry foam  
back polyester fibre filling

### COLOURS



UNTREATED TEAK  
FLAX STRAP

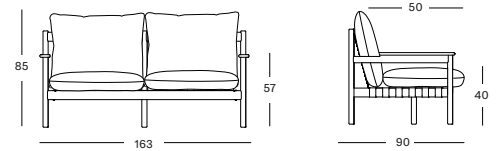

## ODA LOUNGE SOFA 3S

### MATERIALS

untreated teak  
polypropylene straps

### CUSHIONS

seat 14 cm quick dry foam  
back polyester fibre filling

### COLOURS



UNTREATED TEAK  
FLAX STRAP

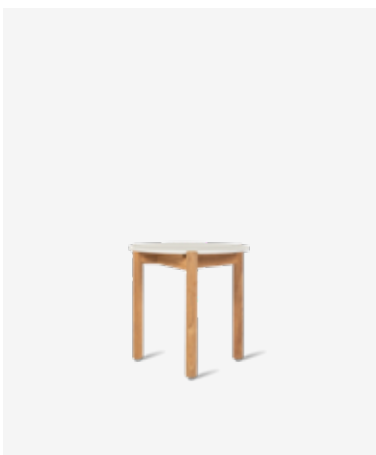
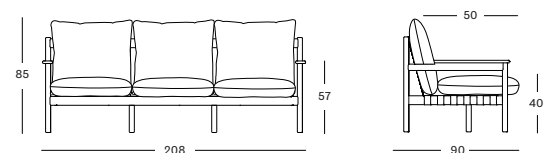

## ODA SIDE TABLE DIA 45

### MATERIALS

untreated teak  
ceramic

### DIMENSIONS

45 cm H x Ø 45 cm

### COLOURS



UNTREATED TEAK  
FLINT CERAMIC

UNTREATED TEAK  
SHARDS CERAMIC

UNTREATED TEAK  
PORTLAND CERAMIC

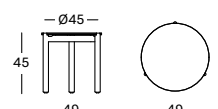





## ODA COFFEE TABLE DIA 68

### MATERIALS

untreated teak  
ceramic

### DIMENSIONS

35 cm H x Ø 68 cm

### COLOURS



UNTREATED TEAK  
FLINT CERAMIC



UNTREATED TEAK  
SHARDS CERAMIC



UNTREATED TEAK  
PORTLAND CERAMIC

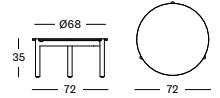

## ODA COFFEE TABLE DIA 90

### MATERIALS

untreated teak  
ceramic

### DIMENSIONS

30 cm H x Ø 90 cm

### COLOURS



UNTREATED TEAK  
FLINT CERAMIC



UNTREATED TEAK  
SHARDS CERAMIC



UNTREATED TEAK  
PORTLAND CERAMIC

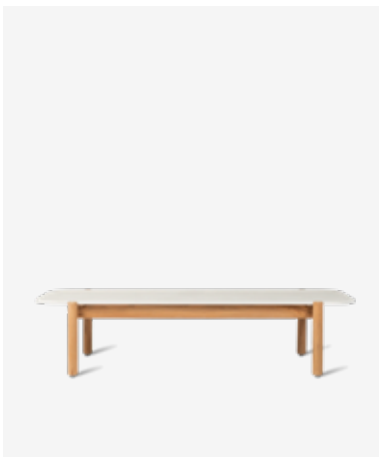
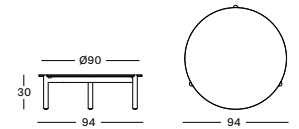

## ODA COFFEE TABLE 129X53

### MATERIALS

untreated teak  
ceramic

### DIMENSIONS

30 cm H x 53 cm x 129 cm

### COLOURS



UNTREATED TEAK  
FLINT CERAMIC



UNTREATED TEAK  
SHARDS CERAMIC



UNTREATED TEAK  
PORTLAND CERAMIC



# KODO

Contemporary outdoor elegance which beckons both comfort and style.  
Designed by Studio Segers

MODULAR SOFA - DEEP SOFA - LOUNGE SOFA - LOUNGE CHAIR - COCOON - ROCKING CHAIR - FOOTREST  
SUNLOUNGER - SIDE TABLE - COFFEE TABLE - DAYBED - DINING CHAIR - DINING TABLE









KODO DEEP SOFA AND MODULAR SOFA dune white  
ROUND COFFEE TABLES dune white | ceramic portland









LEFT PAGE: KODO LOUNGE CHAIR, LOUNGE SOFA AND COFFEE TABLE dune white | ceramic shards  
RIGHT PAGE: KODO ROCKING CHAIR AND SIDE TABLE dune white | ceramic shards







KODO DAYBED fossil grey  
MORA LAMP MEDIUM AND LARGE











KODO LOUNGE CHAIR AND SOFA fossil grey  
KODO COFFEE TABLE AND SIDE TABLE fossil grey | ceramic flint





KODO DINING CHAIR fossil grey  
KODO DINING TABLE fossil grey | ceramic flint





LEFT PAGE: KODO COCOON dune white  
RIGHT PAGE: KODO SUNLOUNGER dune white









## KODO DINING CHAIR

### MATERIALS

powder coated aluminium  
polypropylene rope

### CUSHION

seat 4 cm quick dry foam

### COLOURS



FOSSIL GREY DUNE WHITE

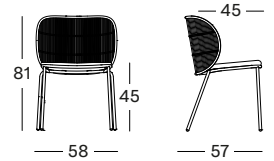

## KODO COCOON

### MATERIALS

powder coated aluminium  
polypropylene rope

### CUSHIONS

- seat 12 cm quick dry foam + deco 1x (60x60), 2x (40x40)
- seat 12 cm quick dry foam +back polyester fibre filling and deco 1x (35x50)

### COLOURS



FOSSIL GREY DUNE WHITE

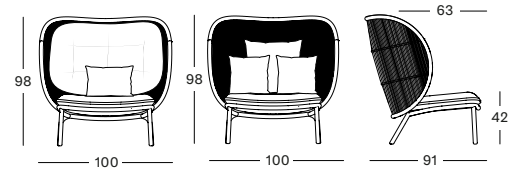

## KODO LOUNGE CHAIR

### MATERIALS

powder coated aluminium  
polypropylene rope

### CUSHIONS

seat 12 cm quick dry foam  
deco 1x (50x50), 1x (40x40)

### COLOURS



FOSSIL GREY DUNE WHITE

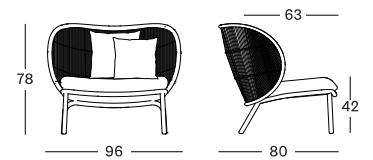

## KODO ROCKING CHAIR

### MATERIALS

powder coated aluminium and teak slats  
polypropylene rope

### CUSHIONS

- seat 12 cm quick dry foam + deco 1x (60 x60), 2x (40x40)
- seat 12 cm quick dry foam + back polyester fibre filling and deco 1x (35x50)

### COLOURS



FOSSIL GREY DUNE WHITE

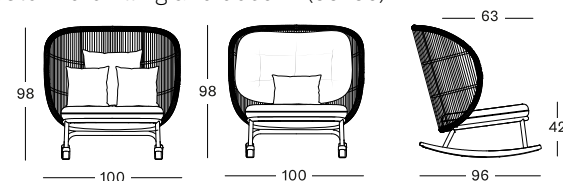



## KODO FOOTREST

### MATERIALS

powder coated aluminium

### CUSHION

footrest 12 cm quick dry foam

### COLOURS



FOSSIL GREY DUNE WHITE

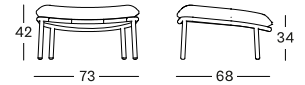

## KODO LOUNGE SOFA

### MATERIALS

powder coated aluminium  
polypropylene rope

### CUSHIONS

seat 12 cm quick dry foam  
deco 2x (50x50), 3x (40x40)

### COLOURS



FOSSIL GREY DUNE WHITE

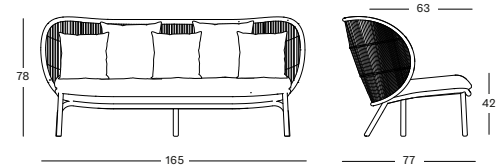

## KODO DAYBED

### MATERIALS

powder coated aluminium  
polypropylene rope

### CUSHIONS

seat 12 cm quick dry foam  
deco 2x (60x60), 3x (50x50), 2x (40x40)

### COLOURS



FOSSIL GREY DUNE WHITE

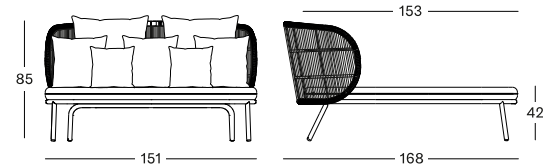

## KODO DINING TABLE

### MATERIALS

powder coated aluminium  
ceramic top

### DIMENSIONS

210 x 100 cm  
280 x 106 cm

### COLOURS



FOSSIL GREY FLINT DUNE WHITE SHARDS DUNE WHITE PORTLAND

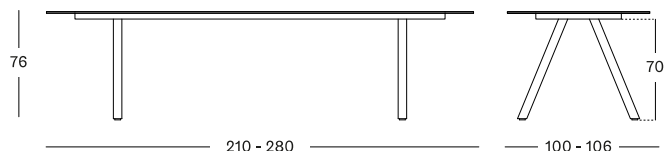



## KODO MODULAR 1 SEATER RIGHT

### MATERIALS

powder coated aluminium  
polypropylene rope

### CUSHION

seat 14 cm quick dry foam  
back polyester fibre filling

### COLOUR



DUNE WHITE

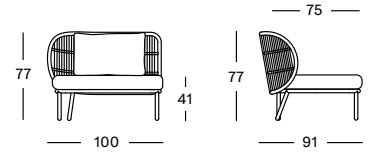

## KODO MODULAR 2 SEATER RIGHT

### MATERIALS

powder coated aluminium  
polypropylene rope

### CUSHIONS

seat 14 cm quick dry foam  
back polyester fibre filling

### COLOUR



DUNE WHITE

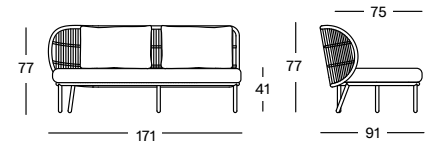

## KODO MODULAR CHAISE LONGUE RIGHT

### MATERIALS

powder coated aluminium  
polypropylene rope

### CUSHION

seat 14 cm quick dry foam  
back polyester fibre filling

### COLOUR



DUNE WHITE

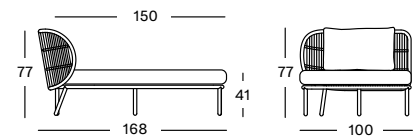

## KODO MODULAR CENTER

### MATERIALS

powder coated aluminium  
polypropylene rope

### CUSHIONS

seat 14 cm quick dry foam  
back polyester fibre filling

### COLOUR



DUNE WHITE

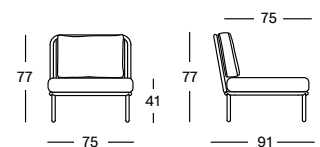



### KODO MODULAR 1 SEATER LEFT

#### MATERIALS

powder coated aluminium  
polypropylene rope

#### CUSHION

seat 14 cm quick dry foam  
back polyester fibre filling

#### COLOUR



DUNE WHITE

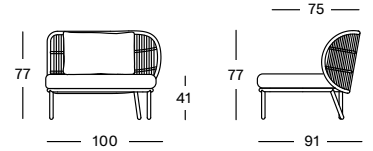

### KODO MODULAR 2 SEATER LEFT

#### MATERIALS

powder coated aluminium  
polypropylene rope

#### CUSHIONS

seat 14 cm quick dry foam  
back polyester fibre filling

#### COLOUR



DUNE WHITE

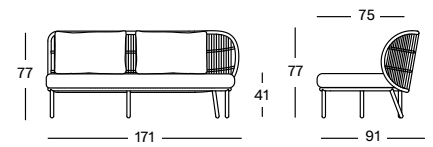

### KODO MODULAR CHAISE LONGUE LEFT

#### MATERIALS

powder coated aluminium  
polypropylene rope

#### CUSHION

seat 14 cm quick dry foam  
back polyester fibre filling

#### COLOUR



DUNE WHITE

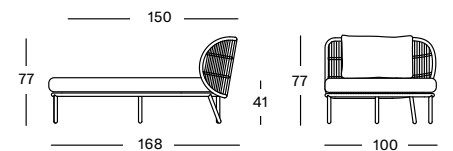

### KODO MODULAR CORNER

#### MATERIALS

powder coated aluminium  
polypropylene rope

#### CUSHIONS

seat 14 cm quick dry foam  
back polyester fibre filling

#### COLOUR



DUNE WHITE

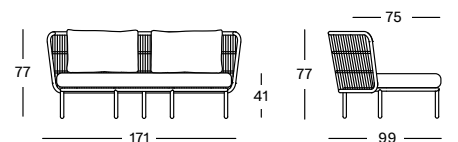



## KODO DEEP SOFA

### MATERIALS

powder coated aluminium  
polypropylene rope

### CUSHIONS

seat 14 cm quick dry foam  
back polyester fibre filling

### COLOURS

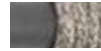

FOSSIL GREY



DUNE WHITE

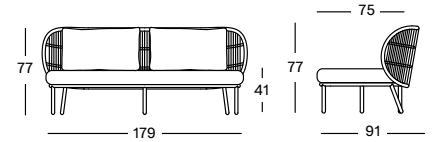

## KODO MODULAR OTTOMAN

### MATERIALS

powder coated aluminium

### CUSHIONS

seat 14 cm quick dry foam

### COLOUR



DUNE WHITE

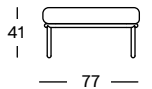

## KODO MODULAR CONNECTING SIDE TABLE

### MATERIALS

powder coated aluminium

### DIMENSIONS

75 x 75 cm  
75 x 59 cm

### COLOUR



DUNE WHITE

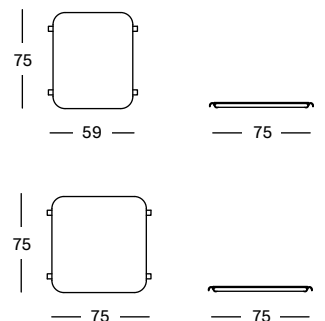

## KODO ROUND SIDE TABLE

### MATERIALS

- powder coated aluminium with aluminium top
- powder coated aluminium with ceramic top

### DIMENSIONS

44 cm H x Ø 40 cm

### COLOURS



FOSSIL GREY  
FLINT CERAMIC



DUNE WHITE  
SHARDS CERAMIC

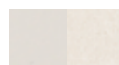

DUNE WHITE  
PORTLAND CERAMIC

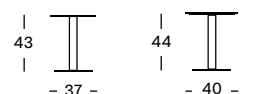





## KODO ROUND COFFEE TABLE DIA 68 & DIA 90

### MATERIALS

- powder coated aluminium with aluminium top
- powder coated aluminium with ceramic top

### DIMENSIONS

36 cm H x Ø 68 cm  
30 cm H x Ø 90 cm

### COLOURS



FOSSIL GREY  
FLINT CERAMIC



DUNE WHITE  
SHARDS CERAMIC



DUNE WHITE  
PORTLAND CERAMIC

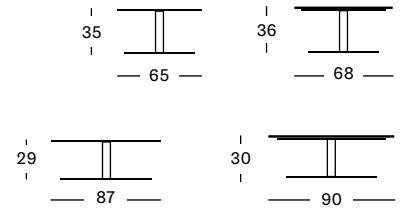

## KODO COFFEE TABLE

### MATERIALS

- powder coated aluminium with aluminium top
- powder coated aluminium with ceramic top

### DIMENSIONS

129 x 45 cm

### COLOURS



FOSSIL GREY  
FLINT CERAMIC



DUNE WHITE  
SHARDS CERAMIC



DUNE WHITE  
PORTLAND CERAMIC

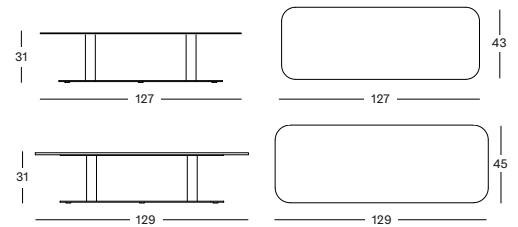

## KODO SIDE TABLE

### MATERIALS

- powder coated aluminium with aluminium top
- powder coated aluminium with ceramic top

### DIMENSIONS

41 x 41 cm

### COLOURS



FOSSIL GREY  
FLINT CERAMIC



DUNE WHITE  
SHARDS CERAMIC



DUNE WHITE  
PORTLAND CERAMIC

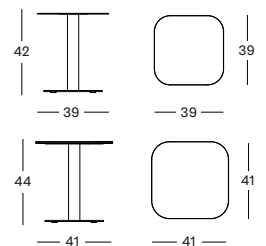

## KODO SUNLOUNGER

### MATERIALS

powder coated aluminium  
polypropylene fibre

### CUSHIONS

3 cm polyether foam filling

### COLOURS



FOSSIL GREY



DUNE WHITE

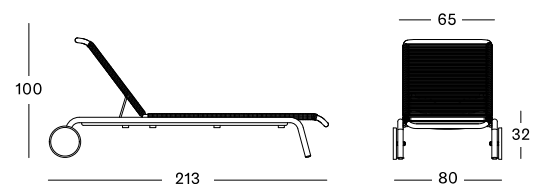

# LENTO

Prominently featured solid teak legs and high woven rope backs give the collection a rich and engaging personality. Designed by Bertrand Lejoly

LOUNGE CHAIR - LOUNGE SOFA - MODULAR SOFA  
MODULAR CHAISE LONGUE- COFFEE TABLE - SIDE TABLE







LENTO LOUNGE CHAIR, MODULAR SOFA AND COFFEE TABLES







LENTO LOUNGE SOFA 2,5S  
COFFEE AND SIDE TABLES





## LENTO LOUNGE CHAIR

### MATERIALS

untreated teak  
polypropylene rope

### CUSHIONS

seat 12 cm quick dry foam  

- back polyester fibre filling
- deco 1 x (50 x 50), 1 x (40 x 40)



UNTREATED TEAK  
ANTHRACITE ROPE

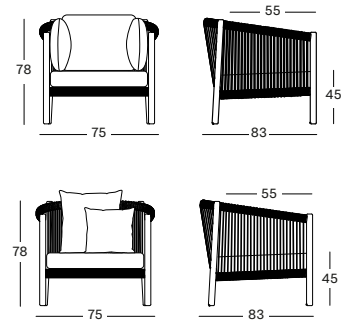

## LENTO LOUNGE SOFA 2.5S

### MATERIALS

untreated teak  
polypropylene rope

### CUSHIONS

seat 12 cm quick dry foam  
back polyester fibre filling

### COLOUR



UNTREATED TEAK  
ANTHRACITE ROPE

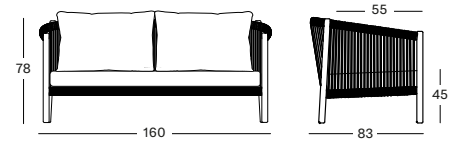

## LENTO LOUNGE SOFA 3S

### MATERIALS

untreated teak  
polypropylene rope

### CUSHIONS

seat 12 cm quick dry foam  
back polyester fibre filling

### COLOUR



UNTREATED TEAK  
ANTHRACITE ROPE

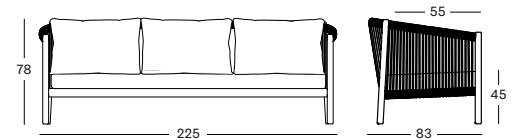

## LENTO COFFEE AND SIDE TABLES

### MATERIALS

untreated teak and aluminium frame  
ceramic top

### DIMENSIONS

44 cm H x Ø 45 cm  
34 cm H x Ø 68 cm  
29 cm H x Ø 90 cm



UNTREATED TEAK  
PORTLAND CERAMIC

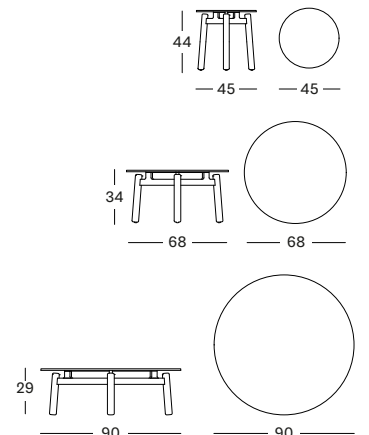



## LENTO MODULAR CORNER RIGHT

### MATERIALS

untreated teak  
polypropylene rope

### CUSHIONS

seat 12 cm quick dry foam  
back polyester fibre filling

### COLOUR



UNTREATED TEAK  
ANTHRACITE ROPE

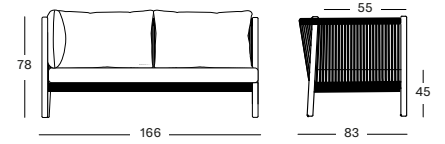

## LENTO MODULAR CORNER LEFT

### MATERIALS

untreated teak  
polypropylene rope

### CUSHIONS

seat 12 cm quick dry foam  
back polyester fibre filling

### COLOUR



UNTREATED TEAK  
ANTHRACITE ROPE

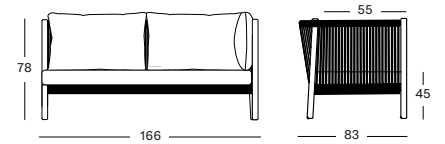

## LENTO MODULAR CONNECTING SIDE TABLE

### MATERIALS

polypropylene rope  
ceramic top

### DIMENSIONS

69 x 37 cm

### COLOUR



PORTLAND CERAMIC  
ANTHRACITE ROPE







## LENTO MODULAR CHAISE LONGUE LEFT

### MATERIALS

untreated teak  
polypropylene rope

### CUSHIONS

seat 12 cm quick dry foam  
back polyester fibre filling

### COLOUR



UNTREATED TEAK  
ANTHRACITE ROPE

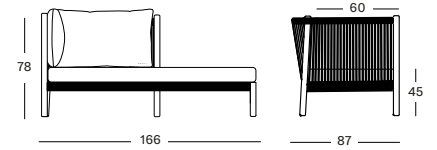

## LENTO MODULAR CHAISE LONGUE RIGHT

### MATERIALS

untreated teak  
polypropylene rope

### CUSHIONS

seat 12 cm quick dry foam  
back polyester fibre filling

### COLOUR



UNTREATED TEAK  
ANTHRACITE ROPE

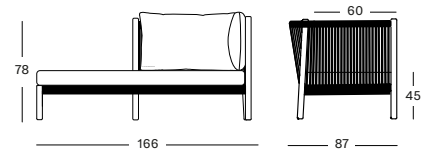

## LENTO MODULAR OTTOMAN

### MATERIALS

untreated teak  
polypropylene rope

### CUSHIONS

seat 12 cm quick dry foam

### COLOUR



UNTREATED TEAK  
ANTHRACITE ROPE

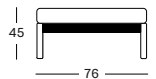

# CLEO

A stylish blend of lightweight aluminum and comfortable woven rope for your outdoor spaces.

LOUNGE CHAIR - LOUNGE SOFA







CLEO LOUNGE CHAIR AND SOFA dune white  
LILO COFFEE AND SIDE TABLE dune white









CLEO DINING CHAIR dune white  
MATTEO DINING TABLE









CLEO DINING CHAIR dune white  
KODO DINING TABLE dune white | ceramic portland





## CLEO DINING ARMCHAIR

### MATERIALS

polypropylene rope  
powder coated aluminium frame

### CUSHIONS

2 cm polyether foam

### COLOUR



**DUNE WHITE/**  
DUNE WHITE    **FOSSIL GREY/**  
MISTY DOTS    **SAGE GREEN/**  
MISTY DOTS

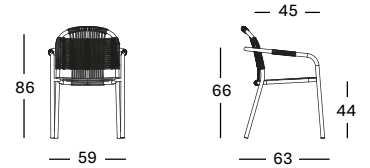

## CLEO LOUNGE CHAIR

### MATERIALS

polypropylene rope  
powder coated aluminium frame

### CUSHIONS

3 cm quick dry foam

### COLOUR



**DUNE WHITE/**  
DUNE WHITE    **FOSSIL GREY/**  
MISTY DOTS    **SAGE GREEN/**  
MISTY DOTS

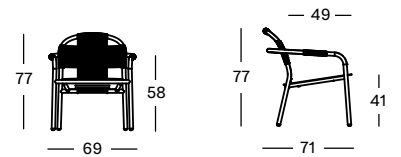

## CLEO LOUNGE SOFA

### MATERIALS

polypropylene rope  
powder coated aluminium frame

### CUSHIONS

3 cm quick dry foam

### COLOUR



**DUNE WHITE/**  
DUNE WHITE    **FOSSIL GREY/**  
MISTY DOTS    **SAGE GREEN/**  
MISTY DOTS

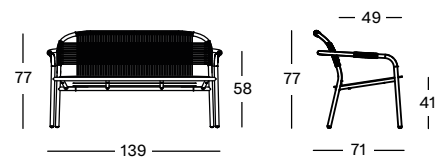

## LILO COFFEE & SIDE TABLES

### MATERIALS

powder coated aluminium frame

### DIMENSIONS

44 cm H x Ø 45 cm  
36 cm H x Ø 60 cm  
30 cm H x Ø 68 cm

### COLOUR



**DUNE**  
WHITE    **FOSSIL**  
GREY    **SAGE**  
GREEN

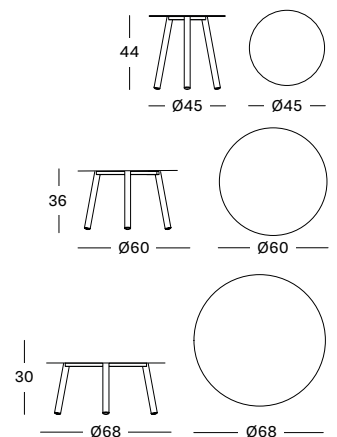

FREYA  
MONA  
NOA  
REMI  
VOLTA

Renowned for its resilience and timeless beauty, teak has the power to transform any space into a sanctuary of elegance.









FREYA DINING ARMCHAIR  
VOLTA DINING TABLE









REMI DINING CHAIR fossil grey  
NOA DINING TABLE









MONA DINING CHAIR old lace







## VOLTA DINING TABLE

### MATERIALS

ceramic top  
untreated teak frame

### DIMENSIONS

240 x 100 cm  
310 x 100 cm

### COLOUR



UNTREATED TEAK  
MASAI BLANCO CERAMIC

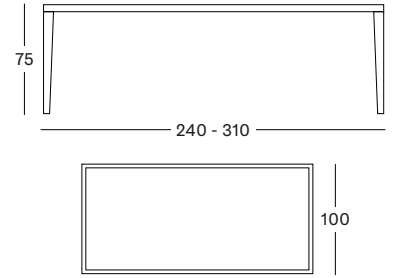

## SAM DINING TABLE

### MATERIALS

untreated solid teak

### DIMENSIONS

75 cm H x Ø 120 cm

### COLOUR



UNTREATED TEAK

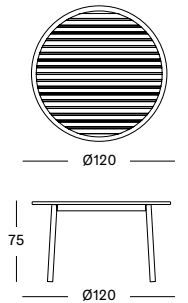

## NOA DINING TABLE

### MATERIALS

untreated solid teak  
powder coated aluminium connection

### DIMENSIONS

75 cm H x Ø 90 cm  
75 cm H x Ø 132 cm  
75 cm H x Ø 150 cm

### COLOUR



UNTREATED TEAK

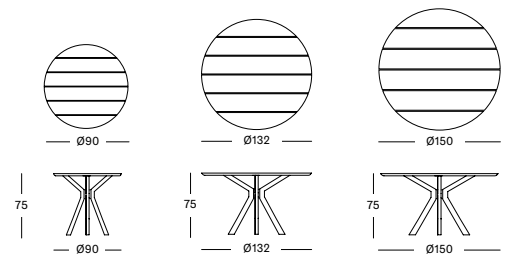

## FREYA DINING ARMCHAIR

### MATERIALS

untreated solid teak

### CUSHION

seat 2 cm polyether foam

### COLOUR



UNTREATED TEAK

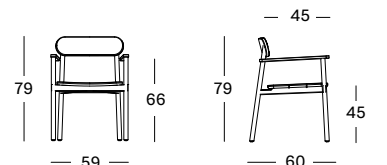





## MONA DINING CHAIR TEAK

### MATERIALS

polyethylene wicker seat  
untreated teak base

### CUSHIONS

2 cm polyether foam

### COLOUR



UNTREATED TEAK  
OLD LACE WICKER

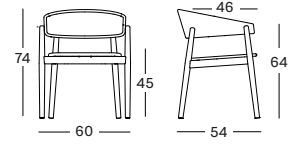

## MONA DINING CHAIR BLACK STAINED BRUSHED TEAK

### MATERIALS

polyethylene wicker seat  
brushed teak base

### CUSHIONS

2 cm polyether foam

### COLOUR



BLACK BRUSHED TEAK  
BLACK WICKER

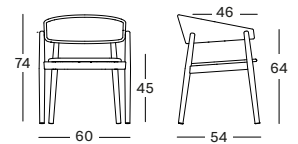

## REMI DINING CHAIR TEAK BASE

### MATERIALS

aluminium and polypropylene rope seat  
teak base

### CUSHIONS

2 cm polyether foam

### COLOURS



UNTREATED TEAK  
FOSSIL GREY      UNTREATED TEAK  
DUNE WHITE

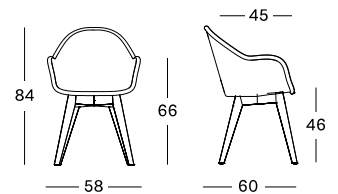

## REMI DINING CHAIR STEEL A BASE

### MATERIALS

aluminium and polypropylene rope seat  
black epoxy coated steel base

### CUSHIONS

2 cm polyether foam

### COLOURS



BLACK STEEL  
FOSSIL GREY      BLACK STEEL  
DUNE WHITE

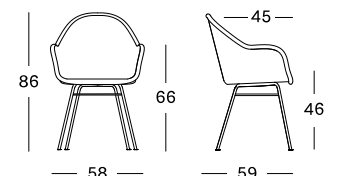

# LEO

The comfortable seating of the tub chair, the laid-back shape of the sofa, and the playful weaving turn it into a real eye catcher.

LOUNGE CHAIR - LOUNGE SOFA - MODULAR SOFA  
SIDE TABLE - COFFEE TABLE - DINING CHAIR - DINING TABLE









LEO LOUNGE CHAIR, MODULAR SOFA AND COFFEE TABLES  
TOUNDRA RUG sahara









LEFT PAGE: LEO DINING CHAIR AND DINING TABLE  
RIGHT PAGE: LEO LOUNGE CHAIR, SOFA AND COFFEE TABLES







### LEO MODULAR CORNER LEFT

#### MATERIALS

powder coated aluminium  
acrylic rope

#### CUSHIONS

seat 12 cm quick dry foam  
back polyester fibre filling + deco 1x (50x50), 1x (40x40)

#### COLOUR



LAVA ALUMINIUM  
LAVA ROPE

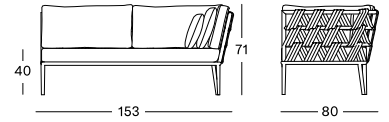

### LEO MODULAR CORNER RIGHT

#### MATERIALS

powder coated aluminium  
acrylic rope

#### CUSHIONS

seat 12 cm quick dry foam  
back polyester fibre filling + deco 1x (50x50), 1x (40x40)

#### COLOUR



LAVA ALUMINIUM  
LAVA ROPE

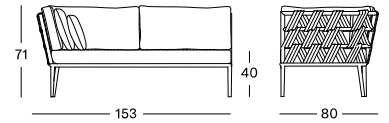

### LEO MODULAR CENTER

#### MATERIALS

powder coated aluminium  
acrylic rope

#### CUSHIONS

seat 12 cm quick dry foam  
back polyester fibre filling

#### COLOUR



LAVA ALUMINIUM  
LAVA ROPE

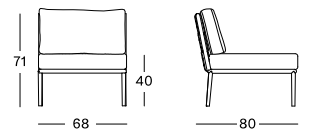

### LEO MODULAR FOOTREST

#### MATERIALS

powder coated aluminium

#### CUSHION

seat 12 cm quick dry foam

#### COLOUR



LAVA ALUMINIUM

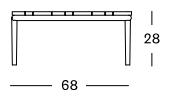





## LEO LOUNGE CHAIR

### MATERIALS

powder coated aluminium  
acrylic rope

### CUSHIONS

seat 12 cm quick dry foam  
back polyester fibre filling

### COLOUR



LAVA ALUMINIUM  
LAVA ROPE

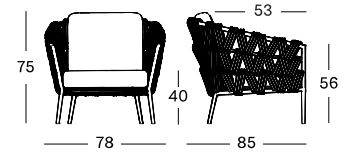

## LEO LOUNGE SOFA

### MATERIALS

powder coated aluminium  
acrylic rope

### CUSHIONS

seat 12 cm quick dry foam  
back polyester fibre filling

### COLOUR



LAVA ALUMINIUM  
LAVA ROPE

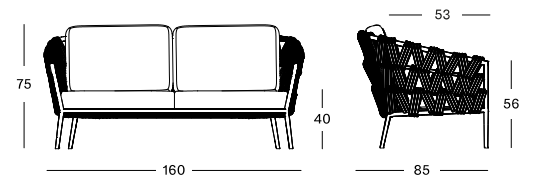

## LEO COFFEE AND SIDE TABLES

### MATERIALS

powder coated aluminium

### DIMENSIONS

48 cm H x Ø 45 cm  
32 cm H x Ø 60 cm  
38 cm H x Ø 70 cm

### COLOUR

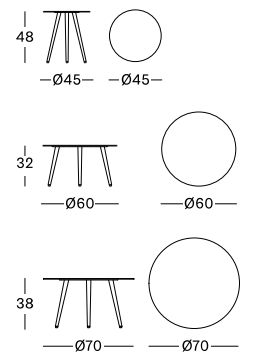

## LEO MODULAR COFFEE TABLE

### MATERIALS

powder coated aluminium  
untreated teak

### DIMENSIONS

68 x 68 cm

### COLOUR



LAVA ALUMINIUM  
UNTREATED TEAK

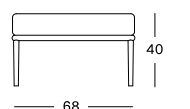







## LEO DINING CHAIR

### MATERIALS

powder coated aluminium  
acrylic rope

### CUSHIONS

seat 4 cm quick dry foam  
back polyester fibre filling

### COLOUR



LAVA ALUMINIUM

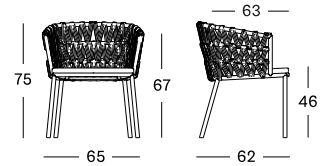

## LEO DINING TABLE 90x90

### MATERIALS

powder coated aluminium  
untreated teak top

### DIMENSIONS

90 x 90 cm

### COLOUR



LAVA ALUMINIUM  
UNTREATED TEAK

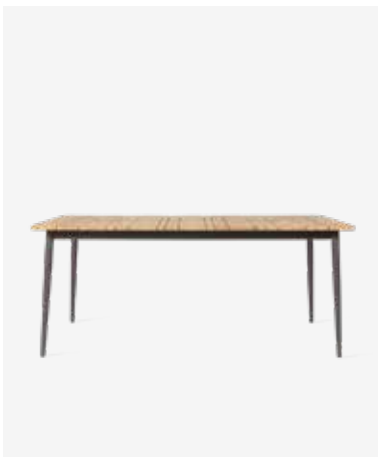
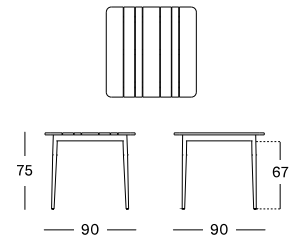

## LEO DINING TABLE

### MATERIALS

powder coated aluminium  
untreated teak top

### DIMENSIONS

180 x 90 cm  
240 x 100 cm

### COLOUR



LAVA ALUMINIUM  
UNTREATED TEAK

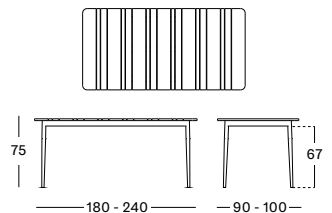

## MAX DINING TABLE

### MATERIALS

powder coated aluminium frame  
untreated teak top or black hpl top (90x90)

### DIMENSIONS

90 x 90 cm (top also available in hpl)  
180 x 90 cm  
240 x 100 cm



BLACK/  
UNTREATED TEAK



FOSSIL GREY/  
UNTREATED TEAK



DUNE WHITE/  
UNTREATED TEAK



BLACK/HPL



FOSSIL GREY/HPL



DUNE WHITE/HPL

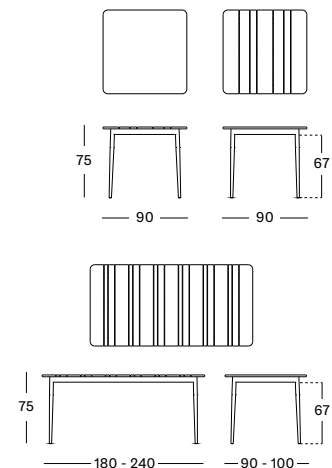



## TOUNDRRA OUTDOOR RUG

### MATERIALS

polyester fibre

### DIMENSIONS

170 x 240 cm

200 x 300 cm

250 x 350 cm

### COLOURS



SAHARA



## CLIFF OUTDOOR RUG

### MATERIALS

polyester fibre

### DIMENSIONS

170 x 240 cm

200 x 300 cm

250 x 350 cm

### COLOURS



CLAY





CLIFF RUG AND ROZY COFFEE TABLE

# DAVID

David's woven back and rope details in a soft earthy tone match perfectly with the solid teak frame and add a sense of tactility.

LOUNGE CHAIR - LOUNGE SOFA - COFFEE TABLE - SIDE TABLE  
DINING CHAIR - DINING TABLE - SUNLOUNGER











DAVID LOUNGE SOFA 2S, LOUNGE CHAIR, COFFEE AND SIDE TABLE  
TOUNDRA RUG sahara



LEFT PAGE: DAVID DINING CHAIR AND DINING TABLE  
RIGHT PAGE: DAVID SUNLOUNGER









## DAVID DINING ARMCHAIR

### MATERIALS

stained brushed teak  
polypropylene rope

### CUSHION

4 cm quick dry foam

### COLOUR



AGED TEAK

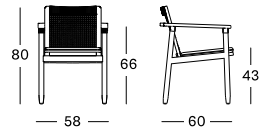

## DAVID DINING TABLE

### MATERIALS

stained brushed teak  
ceramic top

### DIMENSIONS

210 x 100 cm  
280 x 106 cm

### COLOUR



AGED TEAK  
FLINT CERAMIC

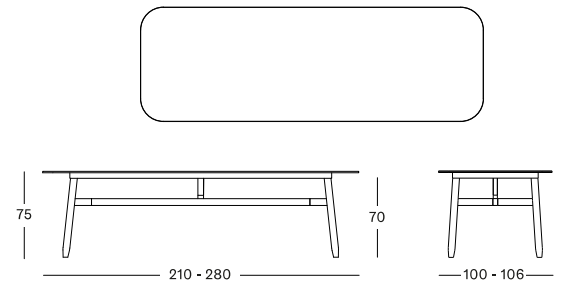

## DAVID SUNLOUNGER

### MATERIALS

stained brushed teak  
polypropylene rope

### CUSHION

6 cm quick dry foam

### COLOUR



AGED TEAK

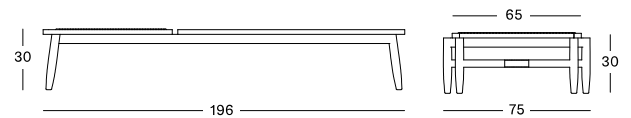

## DAVID ROUND COFFEE & SIDE TABLE

### MATERIALS

stained brushed teak  
ceramic top

### DIMENSIONS

side table: 40 cm H x Ø 40 cm  
coffee table: 34 cm H x Ø 68 cm

### COLOUR

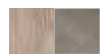

AGED TEAK  
FLINT CERAMIC

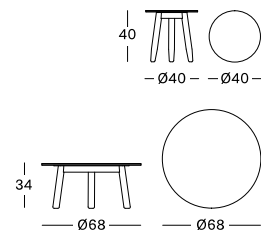





## DAVID LOUNGE CHAIR

### MATERIALS

stained brushed teak  
polypropylene rope

### CUSHIONS

seat 12 cm quick dry foam  
back polyester fibre filling

### COLOUR



AGED TEAK

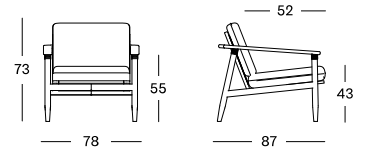

## DAVID LOUNGE SOFA 2S

### MATERIALS

stained brushed teak  
polypropylene rope

### CUSHIONS

seat 12 cm quick dry foam  
back polyester fibre filling

### COLOUR



AGED TEAK

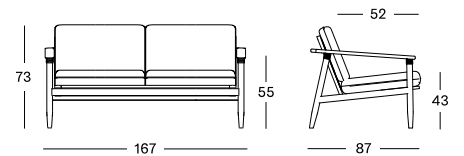

## DAVID LOUNGE SOFA 3S

### MATERIALS

stained brushed teak  
polypropylene rope

### CUSHIONS

seat 12 cm quick dry foam  
back polyester fibre filling

### COLOUR



AGED TEAK

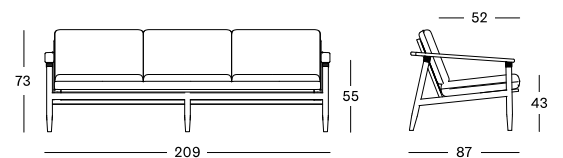

## DAVID COFFEE AND SIDE TABLES

### MATERIALS

stained brushed teak  
ceramic top

### DIMENSIONS

side table: 41 x 41 cm  
coffee table: 120 x 120 cm  
coffee table: 129 x 45 cm

### COLOUR



AGED TEAK  
FLINT CERAMIC

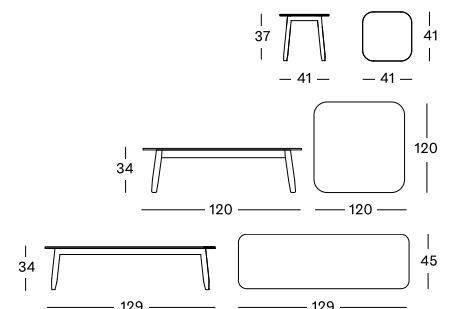

# LOOP

Through its slim profile and see-through weave, which balances utter comfort with ample spatiality, the Loop collection is a symbol of attractive yet functional design.

SOFA - LOUNGE CHAIR - FOOTREST - SUNLOUNGER  
SIDE TABLE - COFFEE TABLE - DINING CHAIR







LEFT PAGE: LOOP LOUNGE CHAIR AND LILO SIDE TABLE dune white  
RIGHT PAGE: LOOP DINING CHAIR moss













LOOP SOFA, LOUNGE CHAIR, COFFEE AND SIDE TABLE fossil grey





## LOOP FOOTREST

### MATERIALS

powder coated aluminium

- polyethylene fibre (black)
- polypropylene rope (other colours)

### COLOURS



BLACK

DUNE WHITE

TAUPE



MOSS

TERRACOTTA

FOSSIL GREY

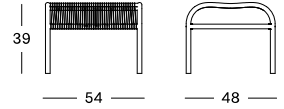

## LOOP SIDE TABLE

### MATERIALS

powder coated aluminium

- polyethylene fibre (black)
- polypropylene rope (other colours)

### COLOURS



BLACK

DUNE WHITE

TAUPE



MOSS

TERRACOTTA

FOSSIL GREY

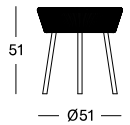

## LOOP COFFEE TABLE

### MATERIALS

powder coated aluminium

- polyethylene fibre (black)
- polypropylene rope (other colours)

### COLOURS



BLACK

DUNE WHITE



TAUPE

FOSSIL GREY

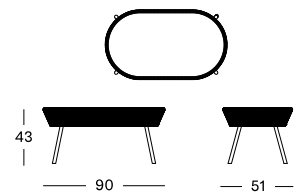





## LOOP DINING CHAIR

### MATERIALS

- powder coated aluminium
- polyethylene fibre (black)
  - polypropylene rope (other colours)

### COLOURS



BLACK

DUNE WHITE

TAUPE

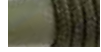

MOSS



TERRACOTTA



FOSSIL GREY

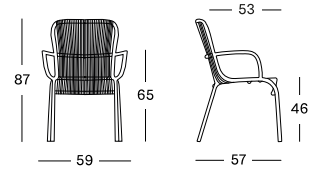

## LOOP LOUNGE CHAIR

### MATERIALS

- powder coated aluminium
- polyethylene fibre (black)
  - polypropylene rope (other colours)

### COLOURS



BLACK

DUNE WHITE

TAUPE

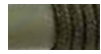

MOSS



TERRACOTTA



FOSSIL GREY

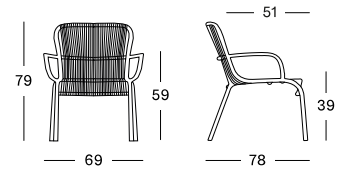

## LOOP SOFA

### MATERIALS

- powder coated aluminium
- polyethylene fibre (black)
  - polypropylene rope (other colours)

### COLOURS



BLACK

DUNE WHITE

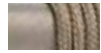

TAUPE



FOSSIL GREY

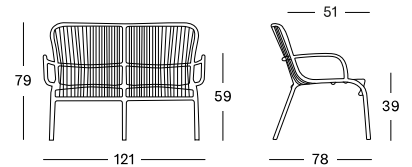

## LOOP SUNLOUNGER

### MATERIALS

- powder coated aluminium
- polyethylene fibre (black)
  - polypropylene rope (other colours)

### CUSHIONS

3 cm polyether foam

### COLOURS



BLACK

DUNE WHITE

TAUPE

FOSSIL GREY

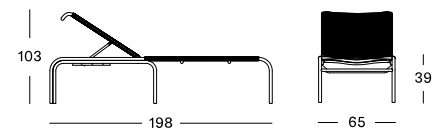

# LIGHTING

Extend the evenings and illuminate your outdoor experience with stunning lighting designs.

MAYA - TIKA - MORA - LIGHT MY TABLE







TIKA AND MAYA LAMPS





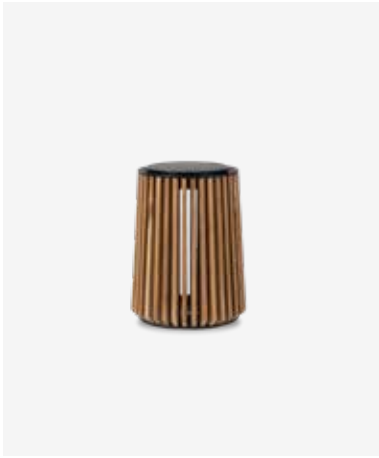

## MAYA LAMP SMALL

### MATERIALS

repurposed teak slats  
casted aluminium frame  
solar-powered LED module

### DIMENSIONS

34 cm H x Ø 27 cm

### COLOUR



UNTREATED TEAK  
BLACK ALUMINIUM

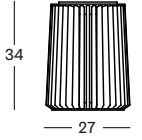

## MAYA LAMP LARGE

### MATERIALS

repurposed teak slats  
casted aluminium frame  
solar-powered LED module

### DIMENSIONS

48 cm H x Ø 28 cm

### COLOUR



UNTREATED TEAK  
BLACK ALUMINIUM

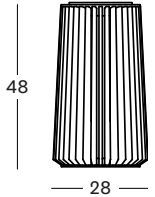













## TIKA LANTERN

### MATERIALS

powder coated aluminium with HDPE wicker  
solar-powered LED module

### DIMENSIONS

40 cm H x Ø 35 cm  
59 cm H x Ø 47 cm

### COLOURS



CAMEL



BLACK

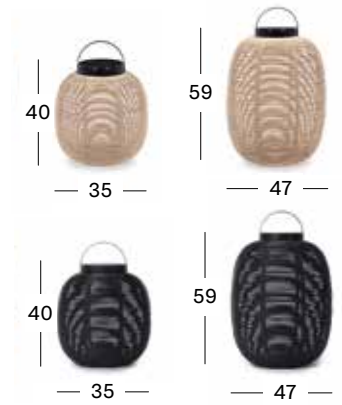

## TIKA LANTERN STEEL BASE

### MATERIALS

powder coated aluminium with HDPE wicker  
solar-powered LED module  
powder coated steel base

### DIMENSIONS

59 cm H x Ø 35 cm  
69 cm H x Ø 47 cm

### COLOURS



CAMEL / BLACK



BLACK / BLACK

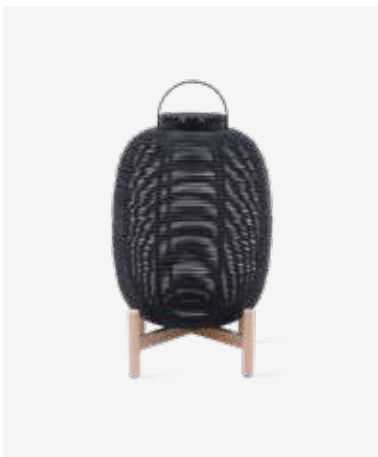

## TIKA LANTERN TEAK BASE

### MATERIALS

powder coated aluminium with HDPE wicker  
solar-powered LED module  
untreated teak base

### DIMENSIONS

59 cm H x Ø 35 cm  
69 cm H x Ø 47 cm

### COLOUR



BLACK / UNTREATED TEAK



## LIGHT MY TABLE

### MATERIALS

black powder coated  
galvanized steel  
leather details  
9 LED lamps 2W

### DIMENSIONS

adjustable 200 – 300 cm  
(for table tops up to 6 cm thick)

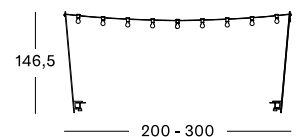



### MORA LAMP WITH HANDLE 54 CM H

#### MATERIALS

powder coated steel  
polypropylene rope  
solar-powered LED module

#### DIMENSIONS

54 cm H x Ø 26 cm

#### COLOUR



FOSSIL GREY ROPE

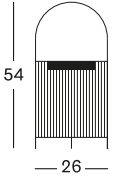

### MORA LAMP 42 CM H X 54 CM DIA

#### MATERIALS

powder coated steel  
polypropylene rope  
solar-powered LED module

#### DIMENSIONS

42 cm H x Ø 54 cm

#### COLOUR



FOSSIL GREY ROPE

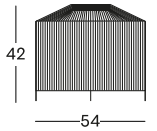

### MORA LAMP 61 CM H X 40 CM DIA

#### MATERIALS

powder coated steel  
polypropylene rope  
solar-powered LED module

#### DIMENSIONS

61 cm H x Ø 40 cm

#### COLOUR



FOSSIL GREY ROPE

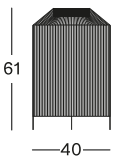





# ROY

The Roy collection combines nostalgic design with innovative materials, giving your outdoor space a strong graphic twist.

LAZY CHAIR - COCOON - DINING CHAIR







LEFT PAGE: ROXY DINING CHAIR black, RONDA BISTRO TABLE AND MAYA LAMP SMALL  
RIGHT PAGE: ROXANNE DINING CHAIR black AND RONDA BISTRO TABLE













LEFT PAGE: ROY COCOON black  
RIGHT PAGE: ROY LAZY CHAIR camel



## SPHERA BISTRO TABLE

### MATERIALS

black epoxy coated steel base  
untreated teak or black hpl top

### DIMENSIONS

Ø 80 cm

### COLOURS



UNTREATED TEAK    BLACK HPL

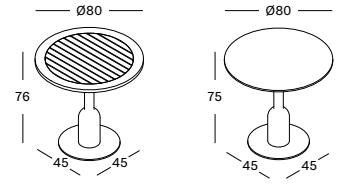

## RONDA BISTRO TABLE

### MATERIALS

black epoxy coated steel base  
untreated teak top or black HPL top

### DIMENSIONS

Ø 110 cm

### COLOURS



UNTREATED TEAK    BLACK HPL

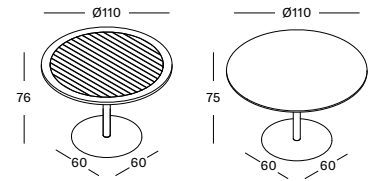

## QUADRO BISTRO TABLE

### MATERIALS

black powder coated steel base  
untreated teak or hpl top

### DIMENSIONS

70 x 70 cm

### COLOURS



UNTREATED TEAK    BLACK HPL

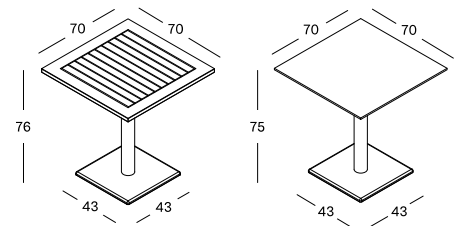

## MAX DINING TABLE

### MATERIALS

powder coated aluminium frame  
untreated teak top or black hpl top (90x90)

### DIMENSIONS

90 x 90 cm (also available in hpl)  
180 x 90 cm  
240 x 100 cm



BLACK/UNTREATED TEAK



FOSSIL GREY/UNTREATED TEAK



DUNE WHITE/UNTREATED TEAK



BLACK/HPL



FOSSIL GREY/HPL



DUNE WHITE/HPL

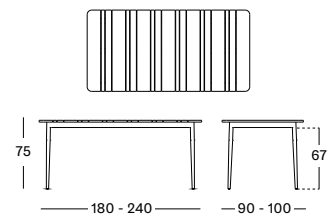
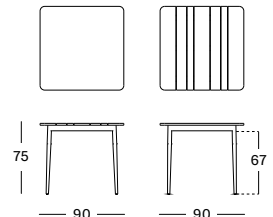





### ROXANNE DINING CHAIR

#### MATERIALS

aluminium and polyethylene wicker seat  
black epoxy coated steel base

#### CUSHIONS

seat 2 cm polyether foam

#### COLOURS



CAMEL WICKER    BLACK WICKER

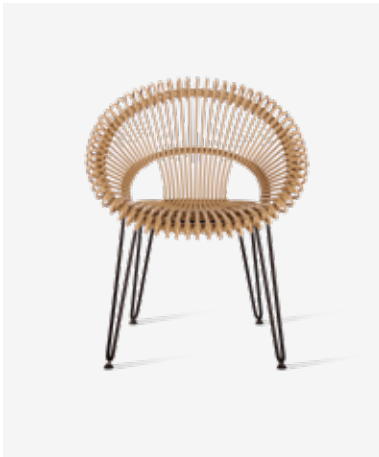
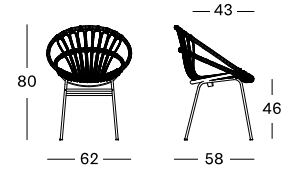

### ROXY DINING CHAIR

#### MATERIALS

aluminium and polyethylene wicker seat  
black epoxy coated steel base

#### CUSHIONS

seat 2 cm polyether foam

#### COLOURS



CAMEL WICKER    BLACK WICKER

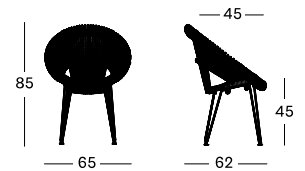

### ROY LAZY CHAIR

#### MATERIALS

aluminium and polyethylene wicker seat  
black epoxy coated steel base

#### CUSHIONS

seat 2 cm polyether foam

#### COLOURS



CAMEL WICKER    BLACK WICKER

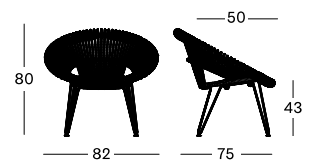

### ROY COCOON

#### MATERIALS

aluminium and polyethylene wicker seat  
black epoxy coated steel base

#### CUSHIONS

seat 8 cm quick dry foam

#### COLOURS



CAMEL WICKER    BLACK WICKER

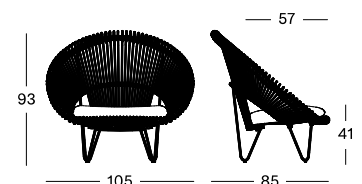







## ROZY SIDE TABLE

### MATERIALS

epoxy coated steel  
black hpl

### DIMENSIONS

50 x 49 x 42 cm

### COLOUR



BLACK HPL

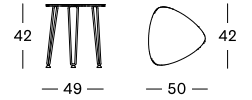

## ROZY COFFEE TABLE

### MATERIALS

epoxy coated steel  
black hpl

### DIMENSIONS

99 x 114 x 72 cm

### COLOUR



BLACK HPL

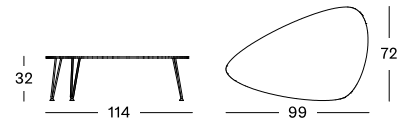

# WICKED

By creating an unexpectedly light and airy shape, Belgian designer Alain Gilles managed to shed new light onto the traditional wicker furniture.

LOUNGE CHAIR - LOUNGE SOFA - SIDE TABLE - COFFEE TABLE - DINING CHAIR - DINING TABLE







WICKED LOUNGE SOFA 2S AND LOUNGE CHAIR taupe  
COFFEE AND SIDE TABLE









WICKED LOUNGE CHAIR taupe





WICKED DINING CHAIR taupe  
WICKED DINING TABLE



## WICKED DINING CHAIR

### MATERIALS

powder coated aluminium  
polyethylene wicker

### CUSHIONS

2 cm polyether foam

### COLOURS



BLACK  
TAUPE



WHITE  
NATURAL

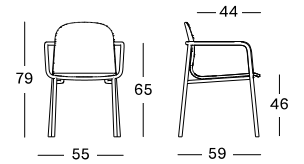

## WICKED DINING TABLE

### MATERIALS

powder coated aluminium  
untreated teak

### DIMENSIONS

200 x 90 cm  
250 x 90 cm

### COLOURS



BLACK ALUMINIUM  
UNTREATED TEAK



WHITE ALUMINIUM  
UNTREATED TEAK

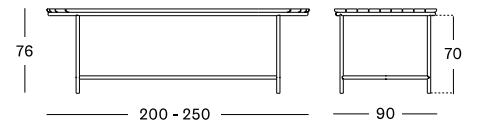
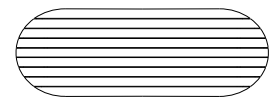

## WICKED SIDE TABLE

### MATERIALS

powder coated aluminium  
untreated teak

### DIMENSIONS

Ø 37 cm

### COLOURS



BLACK ALUMINIUM  
UNTREATED TEAK



WHITE ALUMINIUM  
UNTREATED TEAK

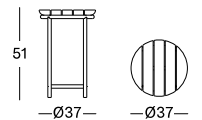

## WICKED COFFEE TABLE

### MATERIALS

powder coated aluminium  
untreated teak

### DIMENSIONS

123 x 55 cm

### COLOURS



BLACK ALUMINIUM  
UNTREATED TEAK



WHITE ALUMINIUM  
UNTREATED TEAK

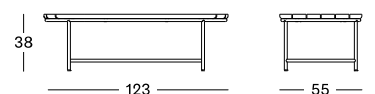





## WICKED LOUNGE CHAIR

### MATERIALS

powder coated aluminium  
polyethylene wicker

### CUSHIONS

seat 10 cm quick dry foam  
deco 1 x (40x40)

### COLOURS



BLACK  
TAUPE



WHITE  
NATURAL

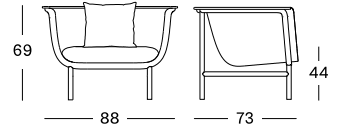

## WICKED LOUNGE SOFA 2S

### MATERIALS

powder coated aluminium  
polyethylene wicker

### CUSHIONS

seat 10 cm quick dry foam  
deco 2x (45x50), 3x (40x40)

### COLOURS



BLACK  
TAUPE



WHITE  
NATURAL

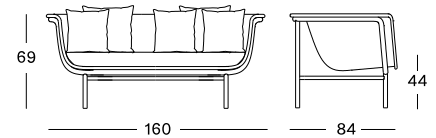

## WICKED LOUNGE SOFA 3S

### MATERIALS

powder coated aluminium  
polyethylene wicker

### CUSHIONS

seat 10 cm quick dry foam  
deco 3x (45x50), 2x (40x40)

### COLOURS



BLACK  
TAUPE



WHITE  
NATURAL

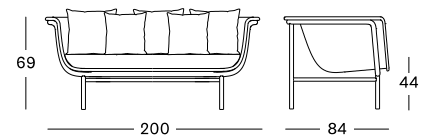

# EDGARD LENA GIPSY

Woven wicker furniture 100% fit for outdoor use all year round

DINING CHAIR - BAR STOOL - LOUNGE CHAIR - COCOON













EDGARD DINING CHAIR old lace  
NOA DINING TABLE





LEFT PAGE: GIPSY DINING CHAIR AND WICKED DINING TABLE  
RIGHT PAGE: GIPSY LOUNGE CHAIR AND IVO COFFEE TABLE









EDGARD DINING CHAIR black  
MATTEO DINING TABLE AND LIGHT MY TABLE







LENA DINING CHAIR old lace





## EDGARD DINING CHAIR TEAK BASE

### MATERIALS

aluminium and polyethylene wicker seat  
teak base

### CUSHIONS

2 cm polyether foam

### COLOURS



UNTREATED TEAK  
OLD LACE



UNTREATED TEAK  
MOCCA



UNTREATED TEAK  
BLACK

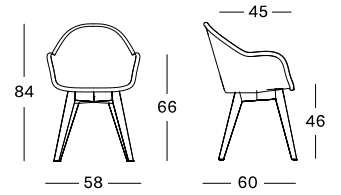

## EDGARD DINING CHAIR STEEL A BASE

### MATERIALS

aluminium and polyethylene wicker seat  
black epoxy coated steel base

### CUSHIONS

2 cm polyether foam

### COLOURS



BLACK  
OLD LACE



BLACK  
MOCCA



BLACK  
BLACK

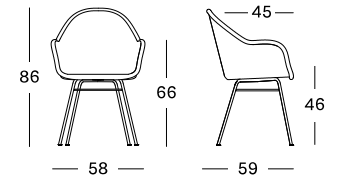

## LENA DINING CHAIR TEAK BASE

### MATERIALS

aluminium and polyethylene wicker seat  
teak base

### COLOURS



UNTREATED TEAK  
OLD LACE

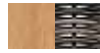

UNTREATED TEAK  
MOCCA



UNTREATED TEAK  
BLACK

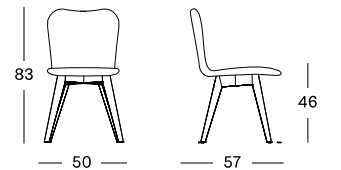

## LENA DINING CHAIR STEEL A BASE

### MATERIALS

aluminium and polyethylene wicker seat  
black epoxy coated steel base

### COLOURS



BLACK  
OLD LACE



BLACK  
MOCCA



BLACK  
BLACK

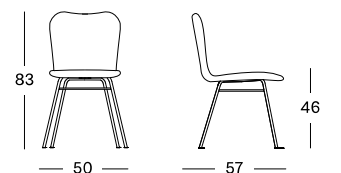



## MATTEO DINING TABLE

### MATERIALS

powder coated aluminium legs  
untreated teak top

### DIMENSIONS

215 x 100 cm  
285 x 100 cm

### COLOURS



BLACK ALUMINIUM  
UNTREATED TEAK

DUNE WHITE ALUMINIUM  
UNTREATED TEAK

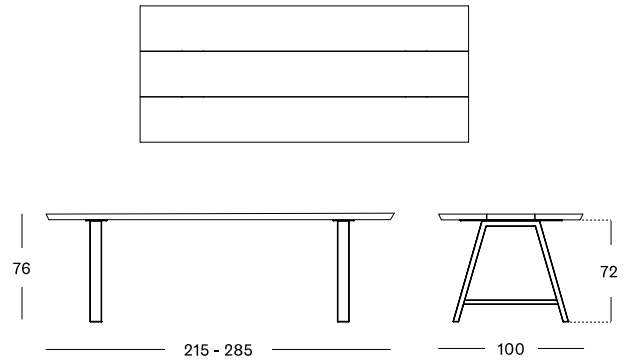

## MATTEO BENCH

### MATERIALS

powder coated aluminium legs  
untreated teak seat

### DIMENSIONS

195 x 40 cm  
265 x 40 cm

### COLOURS



BLACK ALUMINIUM  
UNTREATED TEAK

DUNE WHITE ALUMINIUM  
UNTREATED TEAK

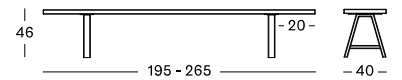

## EDGARD BAR STOOL TEAK BASE

### MATERIALS

aluminium and polyethylene wicker seat  
teak base

### COLOURS



UNTREATED TEAK  
OLD LACE

UNTREATED TEAK  
MOCCA

UNTREATED TEAK  
BLACK

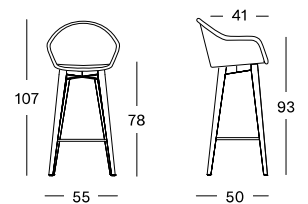

## EDGARD BAR STOOL STEEL BASE

### MATERIALS

aluminium and polyethylene wicker seat  
black epoxy coated steel base

### COLOURS



BLACK  
OLD LACE

BLACK  
MOCCA

BLACK  
BLACK

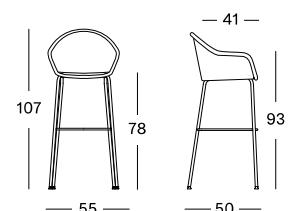





## GIPSY DINING CHAIR

### MATERIALS

aluminium and polyethylene wicker seat  
epoxy and powder coated steel base

### CUSHIONS

2 cm polyether foam

### COLOUR



BLACK STEEL  
BLACK WICKER

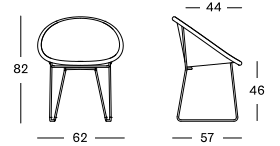

## GIPSY COCOON

### MATERIALS

aluminium and polyethylene wicker seat  
epoxy and black powder coated steel base

### CUSHIONS

8 cm quick dry foam

### COLOUR



BLACK STEEL  
BLACK WICKER

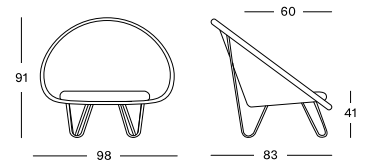

## GIPSY LOUNGE

### MATERIALS

aluminium and polyethylene wicker seat  
epoxy and black powder coated steel base

### CUSHIONS

seat 12 cm quick dry foam  
back 1 x (60x60) and 2x (40x40)

### COLOUR



BLACK STEEL  
BLACK WICKER

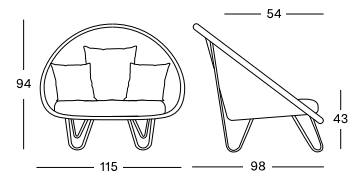



#### IVO SIDE TABLE DIA 44

##### MATERIALS

powder coated aluminium  
HDPE wicker  
hpl

##### DIMENSIONS

45 cm H x Ø 44 cm

##### COLOUR



BLACK WICKER  
BLACK HPL

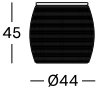

#### IVO COFFEE TABLE DIA 77

##### MATERIALS

powder coated aluminium  
HDPE wicker  
hpl

##### DIMENSIONS

37 cm H x Ø 77 cm

##### COLOUR



BLACK WICKER  
BLACK HPL

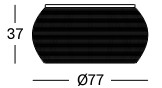

#### IVO COFFEE TABLE DIA 93

##### MATERIALS

powder coated aluminium  
HDPE wicker  
hpl

##### DIMENSIONS

37 cm H x Ø 93 cm

##### COLOUR



BLACK WICKER  
BLACK HPL

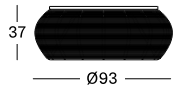





# LUCY

Lucy will inject your terrace and garden with charm and comfort. The soft, flowing round shapes of these chairs invite you to relax in the sun.

LAZY ARMCHAIR - LOUNGE CHAIR - FOOTREST - SIDE TABLE - MODULAR SOFA - DINING CHAIR - SUNLOUNGER







LEFT PAGE: LUCY DINING ARMCHAIR off white  
RIGHT PAGE: LUCY LOUNGE CHAIR off white





















## LUCY DINING CHAIR

### MATERIALS

powder coated aluminium  
polyethylene fibre

### CUSHION

seat 2 cm polyether foam

### COLOUR



OFF WHITE

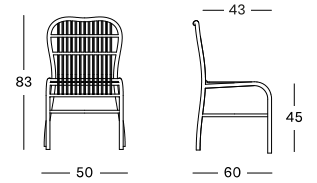

## LUCY DINING ARMCHAIR

### MATERIALS

powder coated aluminium  
polyethylene fibre

### CUSHION

seat 2 cm polyether foam

### COLOUR



OFF WHITE

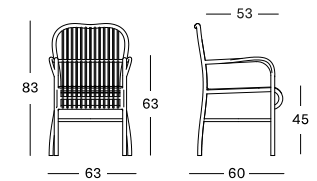

## LUCY SUNLOUNGER

### MATERIALS

powder coated aluminium  
polyethylene fibre

### CUSHION

seat 3 cm polyether foam

### COLOUR



OFF WHITE

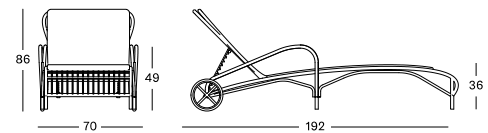



## LUCY LAZY ARMCHAIR

### MATERIALS

powder coated aluminium  
polyethylene fibre

### CUSHION

seat 2 cm polyether foam

### COLOUR



OFF WHITE

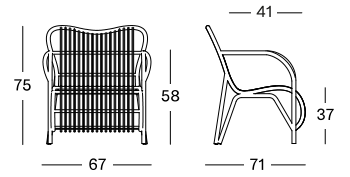

## LUCY LOUNGE CHAIR

### MATERIALS

powder coated aluminium  
polyethylene fibre

### COLOUR



OFF WHITE

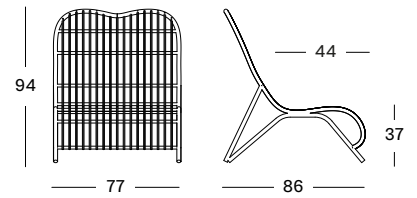

## LUCY FOOTREST

### MATERIALS

powder coated aluminium  
polyethylene fibre

### COLOUR



OFF WHITE

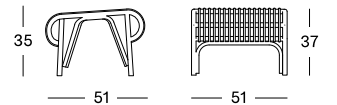

## LUCY SIDE TABLE

### MATERIALS

powder coated aluminium  
polyethylene fibre  
glass

### DIMENSIONS

46 x 46 cm

### COLOUR



OFF WHITE

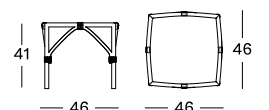





## LUCY MODULAR CORNER

### MATERIALS

powder coated aluminium  
polyethylene fibre

### CUSHIONS

seat 12 cm quick dry foam  
back polyester fibre

### COLOUR



OFF WHITE

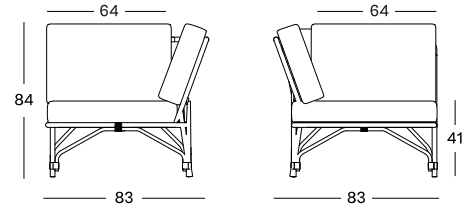

## LUCY MODULAR CENTER

### MATERIALS

powder coated aluminium  
polyethylene fibre

### CUSHIONS

seat 12 cm quick dry foam  
back polyester fibre

### COLOUR



OFF WHITE

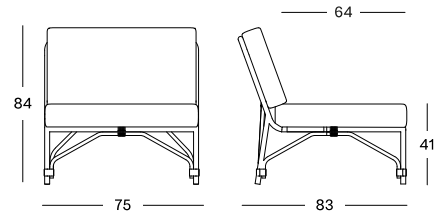

## LUCY OTTOMAN

### MATERIALS

powder coated aluminium  
polyethylene fibre

### CUSHIONS

seat 12 cm quick dry foam

### COLOUR



OFF WHITE

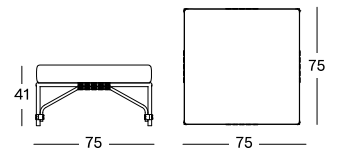

## LUCY MODULAR COFFEE TABLE

### MATERIALS

powder coated aluminium  
polyethylene fibre  
glass

### DIMENSIONS

75 x 75 cm

### COLOUR



OFF WHITE

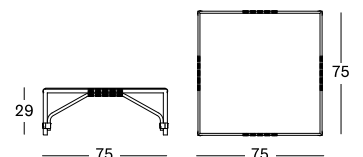

# SAFI

Safi stands for timeless outdoor pleasure. The handwoven furniture gives your terrace a royal comfort and adapts naturally to each environment.

LOUNGE CHAIR - LOUNGE SOFA - SIDE TABLE - SUNLOUNGER - DINING CHAIR - DINING TABLE







SAFI LOUNGE SOFA 2S, LOUNGE SOFA 3S AND LOUNGE CHAIR old lace









LEFT PAGE: SAFI SUNLOUNGER old lace  
RIGHT PAGE: SAFI DINING CHAIR AND DINING TABLE old lace









## SAFI DINING CHAIR

### MATERIALS

powder coated aluminium frame  
polyethylene fibre

### CUSHION

4 cm polyether foam

### COLOUR



OLD LACE

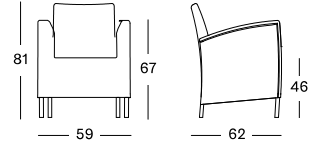

## SAFI DINING TABLE DIA 120

### MATERIALS

powder coated aluminium frame  
polyethylene fibre  
glass (optional)

### DIMENSIONS

Ø 120 cm

### COLOUR



OLD LACE

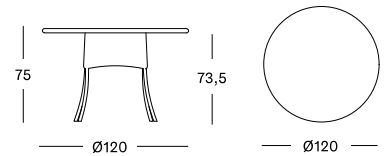

## SAFI SUNLOUNGER

### MATERIALS

powder coated aluminium frame  
polyethylene fibre

### CUSHION

3 cm polyether foam

### COLOUR



OLD LACE

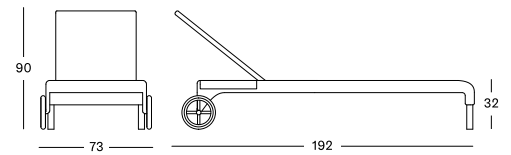

## SAFI SUNLOUNGER WITH ARMS

### MATERIALS

powder coated aluminium frame  
polyethylene fibre

### CUSHION

3 cm polyether foam

### COLOUR



OLD LACE

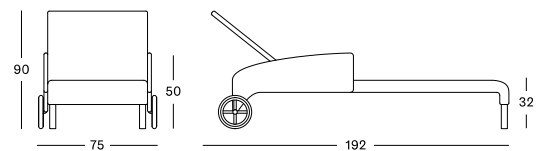





### SAFI LOUNGE CHAIR

#### MATERIALS

powder coated aluminium frame  
polyethylene fibre

#### CUSHION

seat 12 cm quick dry foam  
back polyester fibre

#### COLOUR



OLD LACE

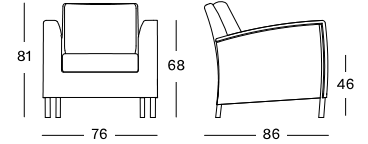

### SAFI LOUNGE SOFA 2S

#### MATERIALS

powder coated aluminium frame  
polyethylene fibre

#### CUSHION

seat 12 cm quick dry foam  
back polyester fibre

#### COLOUR



OLD LACE

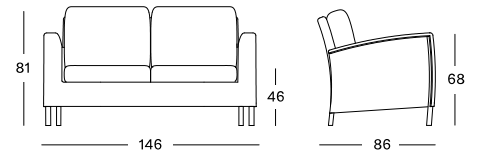

### SAFI LOUNGE SOFA 3S

#### MATERIALS

powder coated aluminium frame  
polyethylene fibre

#### CUSHION

seat 12 cm quick dry foam  
back polyester fibre

#### COLOUR



OLD LACE

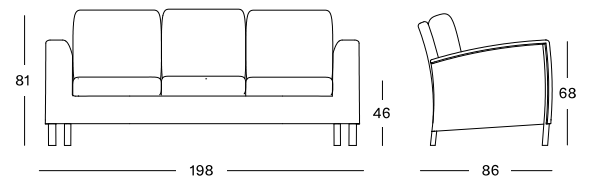

### SAFI SIDE TABLE

#### MATERIALS

powder coated aluminium frame  
polyethylene fibre  
glass (optional)

#### DIMENSIONS

60 x 60 cm

#### COLOUR



OLD LACE

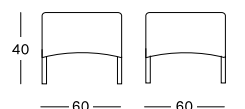



KENZO DINING CHAIR old lace





## MIA DINING CHAIR

### MATERIALS

aluminium frame  
polyethylene wicker

### CUSHIONS

4 cm polyether foam

### COLOURS



OLD LACE

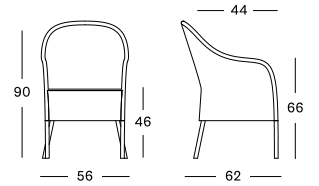

## KENZO DINING CHAIR

### MATERIALS

aluminium frame  
polyethylene wicker

### CUSHIONS

4 cm polyether foam

### COLOURS



OLD LACE

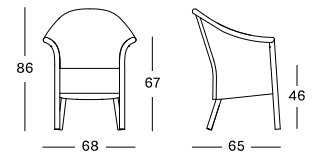

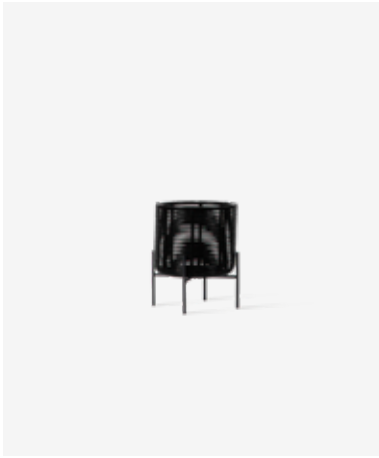

### IVO PLANT STAND SMALL

#### MATERIALS

powder coated aluminium  
HDPE wicker  
plastic saucer

#### DIMENSIONS

36 cm H x Ø 29 cm

#### COLOUR



BLACK ALUMINIUM  
BLACK WICKER

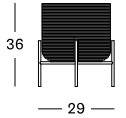

### IVO PLANT STAND MEDIUM

#### MATERIALS

powder coated aluminium  
HDPE wicker  
plastic saucer

#### DIMENSIONS

45 cm H x Ø 40 cm

#### COLOUR



BLACK ALUMINIUM  
BLACK WICKER

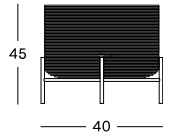

### IVO PLANT STAND LARGE

#### MATERIALS

powder coated aluminium  
HDPE wicker  
plastic saucer

#### DIMENSIONS

65 cm H x Ø 29 cm

#### COLOUR



BLACK ALUMINIUM  
BLACK WICKER

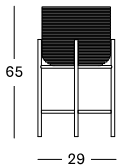





# OUTDOOR

# LLOYD

# LOOM

Lloyd Loom weave is a unique material made of steel and paper. The strong and flexible material is coated with latex for outdoor use.

LOUNGE CHAIR - LOUNGE SOFA - FOOTREST - SIDE TABLE - COFFEE TABLE - SUNLOUNGER - DINING CHAIR - DINING TABLE







MONTE CARLO DINING CHAIR dusty green



















LEFT PAGE: DOVILE DINING CHAIR pure white  
RIGHT PAGE: MONTE CARLO DINING CHAIR AND AVIGNON SIDE TABLE pure white



## DOVILE DINING CHAIR

### MATERIALS

powder coated aluminium frame  
outdoor treated Lloyd Loom weave

### CUSHION

seat 4 cm polyether foam

### COLOURS

see page 167

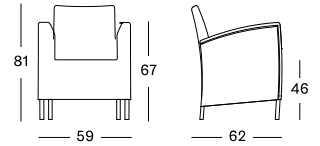

## NIMES TABLE DIA 110 / 130

### MATERIALS

powder coated aluminium frame  
outdoor treated Lloyd Loom weave  
glass (optional)

### DIMENSIONS

Ø 110 cm

Ø 130 cm

### COLOURS

see page 167

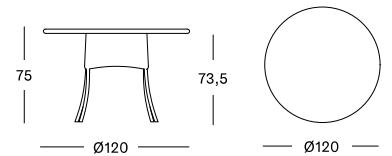

## DOVILE FOOTREST

### MATERIALS

powder coated aluminium frame  
outdoor treated Lloyd Loom weave

### CUSHIONS

seat 11 cm polyether foam

### COLOURS

see page 167

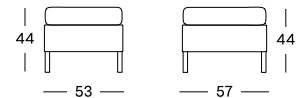

## DOVILE SIDE TABLE

### MATERIALS

powder coated aluminium  
outdoor treated Lloyd Loom weave  
glass (optional)

### DIMENSIONS

60 x 60 cm

### LOOM COLOURS

see page 167

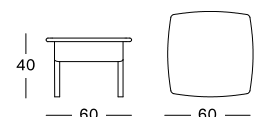





## DOVILE LOUNGE CHAIR

### MATERIALS

powder coated aluminium frame  
outdoor treated Lloyd Loom weave

### CUSHIONS

seat 12 cm high resilience foam  
back polyester fibre

### COLOURS

see page 167

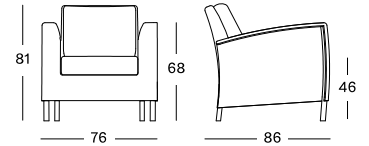

## DOVILE LOUNGE SOFA 2S

### MATERIALS

powder coated aluminium frame  
outdoor treated Lloyd Loom weave

### CUSHIONS

seat 12 cm high resilience foam  
back polyester fibre

### COLOURS

see page 167

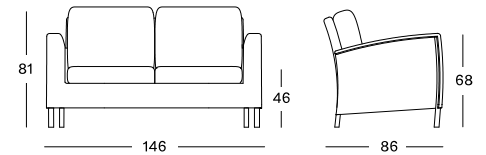

## DOVILE LOUNGE SOFA 3S

### MATERIALS

powder coated aluminium frame  
outdoor treated Lloyd Loom weave

### CUSHIONS

seat 12 cm high resilience foam  
back polyester fibre

### COLOURS

see page 167

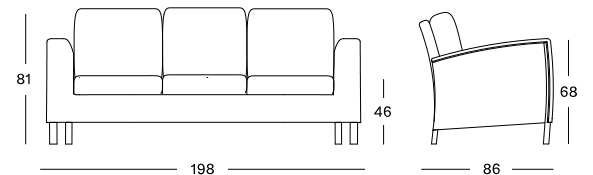

## DOVILE COFFEE TABLE

### MATERIALS

powder coated aluminium frame  
outdoor treated Lloyd Loom weave  
glass (optional)

### DIMENSIONS

60 x 106 cm

### LOOM COLOURS

see page 167

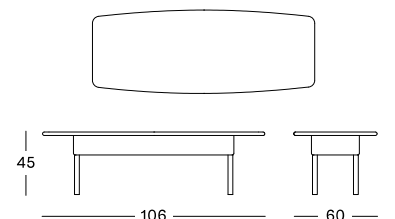



## DOVILE SUNLOUNGER WITH ARMS

### MATERIALS

powder coated aluminium frame  
outdoor treated Lloyd Loom weave

### CUSHION

seat 3 cm polyether foam

### LOOM COLOURS

see page 167

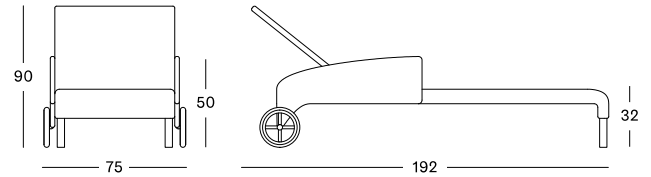

## NICE DINING CHAIR

### MATERIALS

powder coated aluminium frame  
outdoor treated Lloyd Loom weave

### CUSHION

seat 4 cm polyether foam

### LOOM COLOURS

see page 167

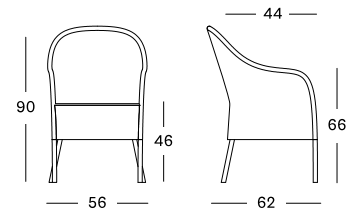

## MONTE CARLO DINING CHAIR

### MATERIALS

powder coated aluminium frame  
outdoor treated Lloyd Loom weave

### CUSHION

seat 4 cm polyether foam

### LOOM COLOURS

see page 167

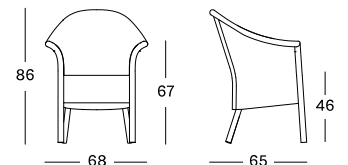

## AVIGNON SIDE TABLE

### MATERIALS

powder coated aluminium frame  
outdoor treated Lloyd Loom weave  
glass (optional)

### DIMENSIONS

60 cm H x Ø 60 cm

### LOOM COLOURS

see page 167

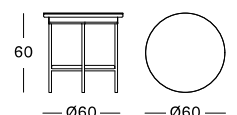



SOLID COLOURS

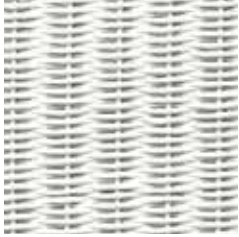

PURE WHITE  
P024

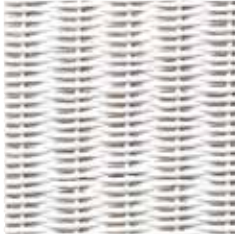

SNOW  
P020



BROKEN WHITE  
P026



PEBBLE  
P025



DUSTY GREEN  
P050

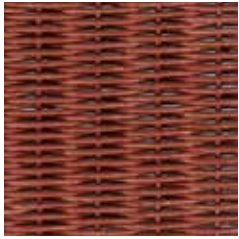

TERRACOTTA  
P035

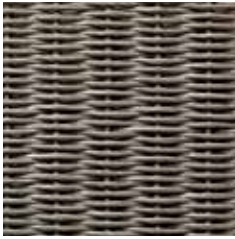

QUARTZ GREY  
P086

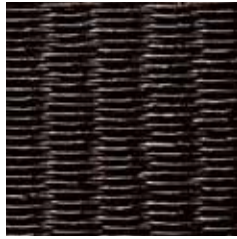

BLACK  
P080

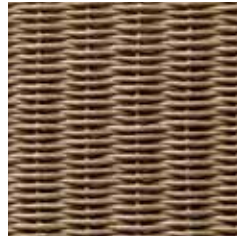

TAUPE  
P084

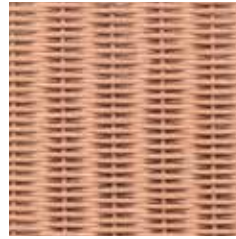

DUSTY CORAL  
P034

METALLIC FINISH

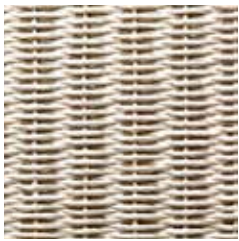

SPARKLE  
P033

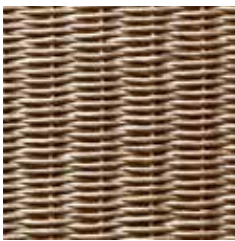

NACR E  
P023

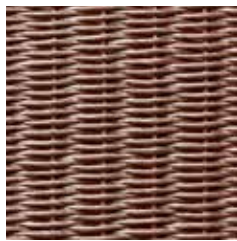

COPPER  
P079

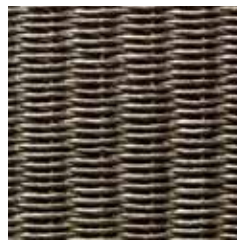

OYSTER  
P036

All colours shown here are as close to the actual colours as the printing process allows.  
Swatches can be supplied on request.

## DECO CUSHIONS



### DECO CUSHION

**DIMENSION**  
60 x 60 cm

**FABRICS**  
see page 174 - 175



### DECO CUSHION

**DIMENSION**  
50 x 50 cm

**FABRICS**  
see page 174 - 175



### DECO CUSHION

**DIMENSION**  
45 x 50 cm

**FABRICS**  
see page 174 - 175



### DECO CUSHION

**DIMENSION**  
40 x 40 cm

**FABRICS**  
see page 174 - 175



### DECO CUSHION

**DIMENSION**  
35 x 50 cm

**FABRICS**  
see page 174 - 175



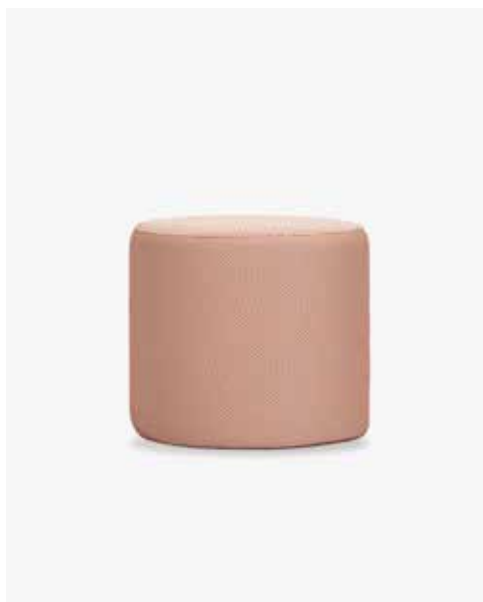

**OLAF DIA 50**

**MATERIALS**

breathable polyester  
polystyrene beads

**DIMENSIONS**

40 cm H x Ø 50 cm

**COLOURS**

quick ship or com fabric

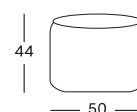

**OLAF DIA 80**

**MATERIALS**

breathable polyester  
polystyrene beads

**DIMENSIONS**

40 cm H x Ø 80 cm

**COLOURS**

Quick ship or com fabric

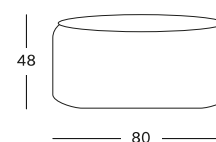

**OTTO**

**MATERIALS**

breathable polyester  
polystyrene beads

**DIMENSIONS**

42 cm H x Ø 52 cm

**COLOURS**



TAUPE

BLACK



MOSS

TERRACOTTA

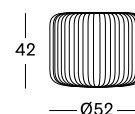





# TECHNICAL INFORMATION

## TEAK

Teak is a tropical hardwood which is known for its strength and durability. Our teak furniture is delivered untreated and will develop a beautiful silvery grey patina. Clean your table once a year with warm soapy water to discourage moss. If you wish to protect your furniture against stains, we recommend treating teak furniture with a teak sealant. As teak is a natural product, small cracks may develop over time.

## ALUMINIUM

Aluminium is a light-weight material which is mainly used as an alternative for steel. Aluminium has a self-protective layer, which prevents corrosion and makes this material very suitable for outdoor applications. Our aluminium furniture is powder coated, which enables us to offer a wide variety of colours. On top of that, it is super easy to maintain. A quick wash with a non-foaming mild detergent every now and then is all it needs!

## SYNTHETIC WEAVE

For our all-weather outdoor collection, we use multiple synthetic materials, including polyethylene, polypropylene, and HDPE wicker. All our synthetic materials are specifically designed to withstand any weather conditions, are UV-resistant, and can be left outside all year long. We recommend giving them a quick wash when dirty or every three months with a non-foaming mild detergent.



## CERAMIC

Ceramic requires little to no maintenance, yet offers maximum resistance. The material preserves the natural look of stone and offers top of the chart convenience. Ceramic is scratchproof, UV-resistant, stainproof, and resistant to fire and high temperatures. Use pure water or a cleaning solution without soap for ceramic surfaces to clean the table. Please do not use soap.

## OUTDOOR LOOM

Lloyd Loom weave is made from twisted Kraft paper on the one hand, and Kraft paper spun around a steel wire on the other hand. In order to be able to use Lloyd Loom for outside furniture as well, a specific technique was developed to make the material waterproof. Our outdoor Lloyd Loom models can thus simply be left outside, although we recommend storing them inside during cold or rainy periods.

## OUTDOOR HPL

HPL or high-pressure laminate is a very sturdy material which consists of different layers which are pressed together under a high temperature. As a result, the material is very durable and UV-resistant. HPL is used for our table tops and can be used indoors as well as outdoors. The table tops do not require any maintenance except for a quick wash every now and then.

## STEEL

Steel is mainly used for the legs and frames of our furniture pieces. For the outdoor pieces, the steel is always galvanized and powder coated to make sure it is protected from all weather influences.

## RUGS

Vincent Sheppard outdoor rugs are made of polyester fibres. The high-performance rugs are dirt and water-repellent, and are thus easy to maintain. Use a high-pressure water hose to clean spots and blot dry afterwards.



**100% SOLUTION DYED ACRYLIC**

- may be machine-washed at 40°C
- may be tumble dried
- may be ironed, ironing temperature should not be higher than 110°C
- the fabric may be treated with bleach
- may be dry cleaned

**ACRYLIC ROPE**

- may be machine-washed at 40°C
- may be tumble dried
- may be ironed, ironing temperature should not be higher than 110°C
- the fabric may be treated with bleach
- may be dry cleaned

**POLYPROPYLENE ROPE**

- may be machine-washed at 40°C
- may be tumble dried
- may be ironed, ironing temperature should not be higher than 110°C
- the fabric may not be treated with bleach
- do not dry clean

**CUSHIONS**

From snuggling between soft pillows to enjoying a dinner party on a lovely dining chair with seat cushion. Comfortable cushions take your seating experience to the next level.

Vincent Sheppard uses high-quality materials and relies on advanced textile technologies to create its cushions. Our fabrics are water-repellent, breathable, and UV-proof. The cushion's cores consist of outdoor foam, enabling you to leave them outdoors during any weather condition. Still, we recommend storing your cushions for the winter or when not in use for long periods.

Nearly all our cushion covers are removable which makes them look brand-new after a wash. As every fabric has its own characteristics, different washing instructions apply.

**100% POLYOLEFIN**

- may be machine-washed at 40°C with extra care
- do not tumble dry
- may not be ironed
- may be treated with bleach
- do not dry clean

**MIX OF MATERIALS**

- may be machine-washed at 40°C with extra care
- do not tumble dry
- do not iron
- do not bleach
- do not dry clean



**PROTECTIVE COVERS**

In order to protect your furniture and keep maintenance minimal, we have developed special protective covers.

The covers are made of 100% polyurethane and have welded, not stitched seams. Consequently, the covers are 100% waterproof.

**CAT. B CUSHION FABRICS**

Item codes starting with CB or QB



**CANVAS S0606**  
100% SOLUTION DYED ACRYLIC

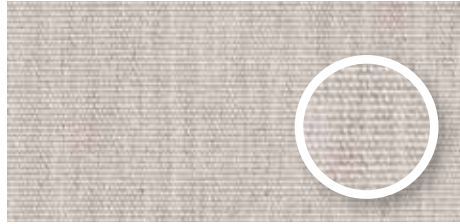

**LIN S1212**  
100% SOLUTION DYED ACRYLIC

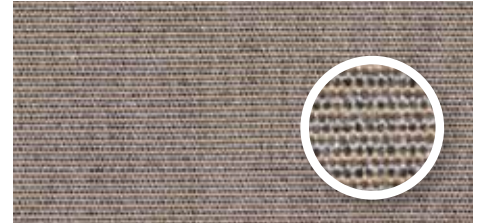

**LONDON STONE S0808**  
100% SOLUTION DYED ACRYLIC

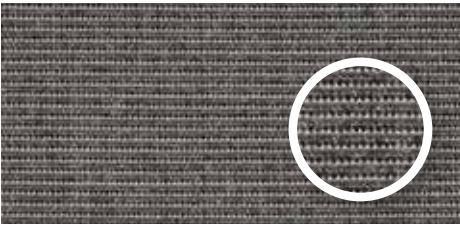

**DARK SMOKE S0909**  
100% SOLUTION DYED ACRYLIC

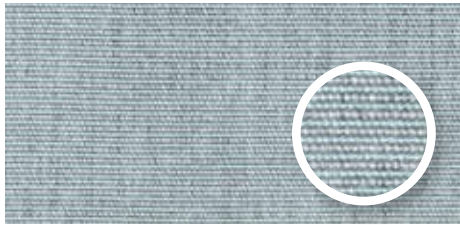

**MINERAL BLUE S1010**  
100% SOLUTION DYED ACRYLIC



**BLUSH S2929**  
100% SOLUTION DYED ACRYLIC



**BLACK S1515**  
100% SOLUTION DYED ACRYLIC



**OLIVE GREEN S2727**  
100% SOLUTION DYED ACRYLIC



**CARBON BEIGE S2828**  
100% SOLUTION DYED ACRYLIC

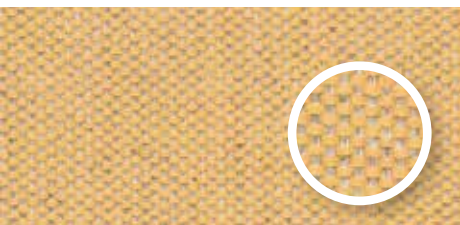

**AMBER S3030**  
100% SOLUTION DYED ACRYLIC



**CAT. C CUSHION FABRICS**

Item codes starting with CC or QC

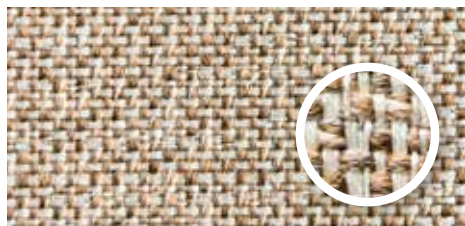

**SAVANE COCONUT S2222**  
100% SOLUTION DYED ACRYLIC

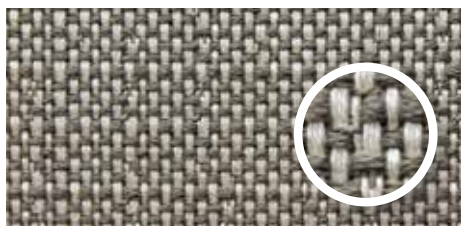

**ZINC S2121**  
100% SOLUTION DYED ACRYLIC



**SPICE P0202**  
100% POLYOLEFIN

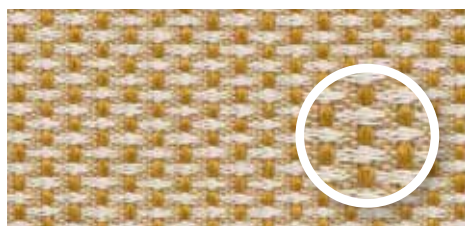

**MUSTARD P0505**  
57% POLYOLEFIN / 43% POLYESTER

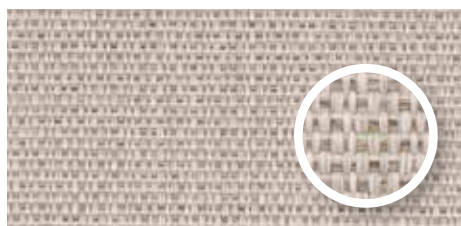

**ALMOND P0303**  
100% POLYPROPYLENE

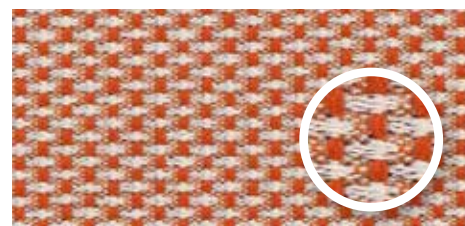

**CORAL P0404**  
57% POLYOLEFIN / 43% POLYESTER

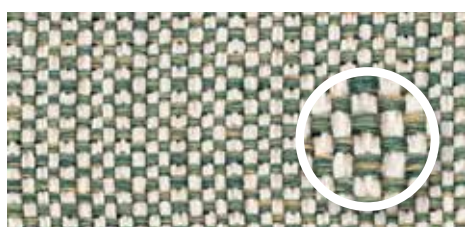

**FIG GREEN M0303**  
100% POLYPROPYLENE

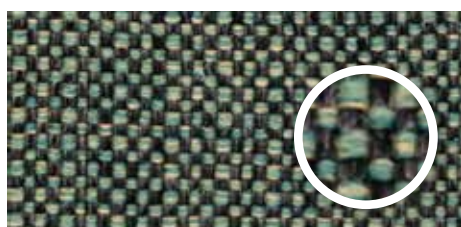

**PINE GREEN M0202**  
100% POLYPROPYLENE

**CAT. G CUSHION FABRICS**

Item codes starting with CG or QG



**LIME WHITE BOUCLÉ M0101**  
100% POLYPROPYLENE

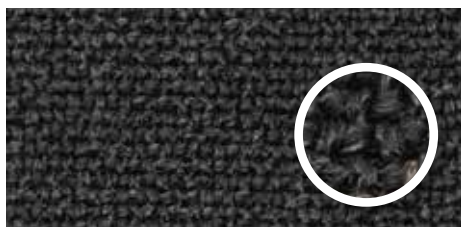

**BLACK BOUCLÉ M0404**  
100% POLYPROPYLENE

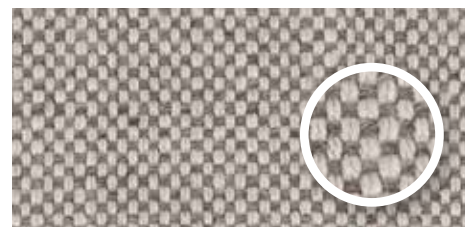

**STONE T0202**  
100% SOLUTION DYED ACRYLIC



**KIWI P0707**  
100% POLYPROPYLENE

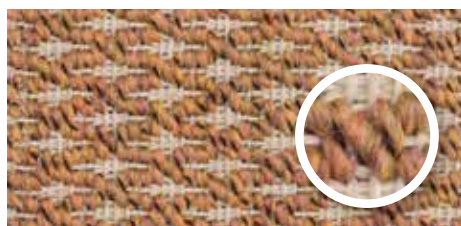

**SIENNA M0505**  
100% POLYPROPYLENE





# PRODUCT OVERVIEW

DINING CHAIRS - BAR STOOLS - LOUNGE CHAIRS - SOFAS - FOOTRESTS - POUFFES  
SUNLOUNGERS - TABLES - BENCHES - COFFEE TABLES - SIDE TABLES - ACCESSORIES



**CLEO DINING CHAIR**  
P 53



**REMI DINING CHAIR**  
P 63



**EDGARD DINING CHAIR**  
P 129



**FRIDA DINING CHAIR**  
P 11



**LENA DINING CHAIR STEEL A BASE**  
P 129



**LENA DINING CHAIR TEAK BASE**  
P 129





**FREYA DINING ARMCHAIR**  
P 62



**KODO DINING CHAIR**  
P 32



**GIPSY DINING CHAIR**  
P 131



**LEO DINING CHAIR**  
P 73



**ROXANNE DINING CHAIR**  
P 109



**ROXY DINING CHAIR**  
P 109



**LOOP DINING CHAIR**  
P 91



**WICKED DINING CHAIR**  
P 118



**MONA DINING CHAIR**  
P 63



**DAVID DINING ARMCHAIR**  
P 82



**LUCY DINING CHAIR**  
P 141



**LUCY DINING ARMCHAIR**  
P 141



## DINING CHAIRS



**MIA DINING CHAIR SYNTHETIC**  
P 153



**KENZO DINING CHAIR SYNTHETIC**  
P 153



**SAFI DINING CHAIR SYNTHETIC**  
P 150



**NICE DINING CHAIR LLOYD LOOM**  
P 166



**DOVILE DINING CHAIR LLOYD LOOM**  
P 164



**MONTE CARLO DINING CHAIR LLOYD LOOM**  
P 166

## BAR STOOLS



**EDGARD BAR STOOL TEAK BASE**  
P 130



**EDGARD BAR STOOL STEEL BASE**  
P 130



**ODA LOUNGE CHAIR**  
P 18



**CLEO LOUNGE CHAIR**  
P 53



**ROY LAZY CHAIR**  
P 109



**ROY COCOON**  
P 109



**LEO LOUNGE CHAIR**  
P 71



**LOOP LOUNGE CHAIR**  
P 91



**LOUNGE CHAIRS**



**LENTO LOUNGE CHAIR**  
P 43



**FRIDA LOUNGE CHAIR**  
P 11



**DAVID LOUNGE CHAIR**  
P 83



**KODO LOUNGE CHAIR**  
P 32



**KODO ROCKING CHAIR**  
P 32



**KODO COCOON**  
P 32



**LOUNGE CHAIRS**



**GIPSY LOUNGE & GIPSY COCOON**  
P 131



**WICKED LOUNGE CHAIR**  
P 119



**DOVILE LOUNGE CHAIR LLOYD LOOM**  
P 165



**SAFI LOUNGE CHAIR SYNTHETIC**  
P 151



**LUCY LAZY ARMCHAIR**  
P 142



**LUCY LOUNGE**  
P 142





**OLAF POUFFE**  
P 169



**OTTO POUFFE (AVAILABLE IN 4 COLOURS)**  
P 169



**KODO FOOTREST**  
P 33



**LOOP FOOTREST**  
P 90



**DOVILE FOOTREST LLOYD  
LOOM**  
P 164



**LUCY FOOTREST**  
P 142

## SUNLOUNGERS



**DAVID SUNLOUNGER**  
P 82



**KODO SUNLOUNGER**  
P 37



**LOOP SUNLOUNGER**  
P 91



**LUCY SUNLOUNGER**  
P 141



**SAFI SUNLOUNGER SYNTHETIC**  
P 150



**SAFI SUNLOUNGER WITH ARMS SYNTHETIC**  
P 150



**DOVILE SUNLOUNGER WITH ARMS LLOYD LOOM**  
P 166





**KODO DEEP SOFA**  
P 36



**CLEO SOFA**  
P 53



**KODO LOUNGE SOFA**  
P 33



**KODO DAYBED**  
P 33



**DAVID LOUNGE SOFA 2S**  
P 83



**DAVID LOUNGE SOFA 3S**  
P 83



**SAFI LOUNGE SOFA 2S**  
**SYNTHETIC**  
P 151



**SAFI LOUNGE SOFA 3S**  
**SYNTHETIC**  
P 151



**DOVILE LOUNGE SOFA 2S LLOYD LOOM**  
P 165



**DOVILE LOUNGE SOFA 3S LLOYD LOOM**  
P 165



**WICKED LOUNGE SOFA 2S**  
P 119



**WICKED LOUNGE SOFA 3S**  
P 119





**ODA LOUNGE SOFA 2.5S**  
P 18



**ODA LOUNGE SOFA 3S**  
P 18



**LEO LOUNGE SOFA**  
P 71



**LOOP SOFA**  
P 91



**LENTO LOUNGE SOFA 2.5S**  
P 43



**LENTO LOUNGE SOFA 3S**  
P 43



**KODO MODULAR SET**  
P 32



**KODO MODULAR 2 SEATER RIGHT**  
P 34



**KODO MODULAR CORNER**  
P 35



**KODO MODULAR 2 SEATER LEFT**  
P 35



**KODO MODULAR 1 SEATER RIGHT**  
P 34



**KODO MODULAR CENTER**  
P 34



**KODO MODULAR COFFEE TABLE**  
P 36



**KODO MODULAR 1 SEATER LEFT**  
P 35



**KODO MODULAR CHAISE LONGUE RIGHT**  
P 34



**KODO MODULAR OTTOMAN**  
P 36



**KODO MODULAR CHAISE LONGUE LEFT**  
P 35

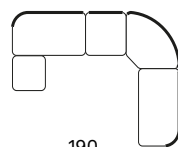
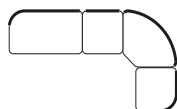
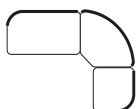





**LENTO MODULAR SET**  
P 44



**LENTO MODULAR CORNER LEFT**  
P 44



**LENTO MODULAR CORNER RIGHT**  
P 44



**LENTO CHAISE LONGUE RIGHT**  
P 45



**LENTO CHAISE LONGUE LEFT**  
P 45



**LENTO MODULAR OTTOMAN**  
P 45



**LENTO MODULAR CONNECTING SIDE TABLE**  
P 44

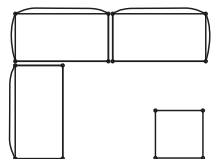
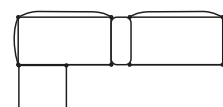
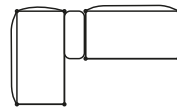
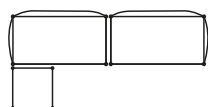
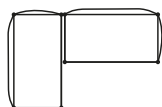
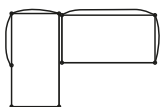



**LEO MODULAR SET**  
P 70



**LEO MODULAR CORNER RIGHT**  
P 70



**LEO MODULAR CORNER LEFT**  
P 70



**LEO MODULAR CENTER**  
P 70



**LEO MODULAR COFFEE TABLE**  
P 70



**LEO MODULAR FOOTREST**  
P 70

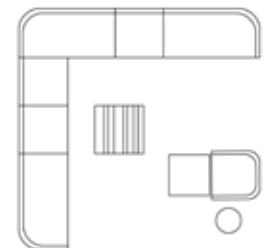
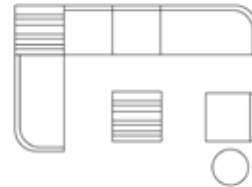
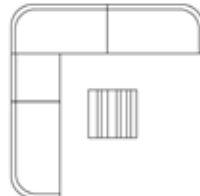
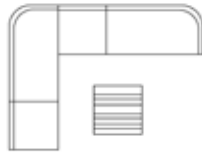





**LUCY MODULAR SET**  
P 143



**LUCY MODULAR CORNER**  
P 143



**LUCY MODULAR CENTER**  
P 143



**LUCY MODULAR OTTOMAN**  
P 143



**LUCY MODULAR COFFEE TABLE**  
P 143

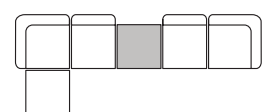
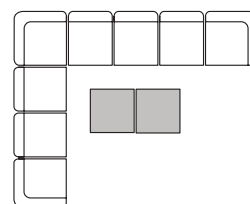
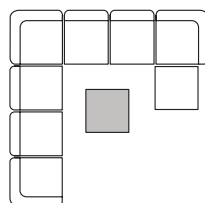
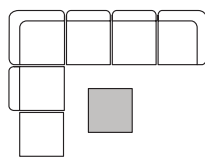
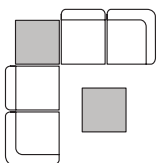



**ODA COFFEE AND SIDE TABLES**  
P 19



**IVO COFFEE AND SIDE TABLE**  
P 132



**WICKED COFFEE TABLE & SIDE TABLE**  
P 118



**LENTO COFFEE & SIDE TABLES**  
P 43



**DAVID COFFEE TABLE DIA 68 & SIDE TABLE DIA 40**  
P 82



**COFFEE & SIDE TABLES**



**DAVID COFFEE TABLE 129 X 45 & SIDE TABLE 41 X 41**  
P 83



**DAVID COFFEE TABLE 120 X 120**  
P 83



**KODO COFFEE TABLE & SIDE TABLE**  
P 37



**KODO ROUND COFFEE TABLES & SIDE TABLE**  
P 36 | 37



**LILO COFFEE AND SIDE TABLES**  
P 53



**AVIGNON SIDE TABLE LLOYD LOOM**  
P 71



**DOVILE COFFEE AND SIDE TABLE LLOYD LOOM**  
P 11



**SAFI SIDE TABLE SYNTHETIC**  
P 111



**LUCY SIDE TABLE**  
P 111



**LOOP COFFEE TABLE**  
P 90



**LOOP SIDE TABLE**  
P 90



**COFFEE & SIDE TABLES**



**LEO COFFEE & SIDE TABLES**  
P 166



**ANTON TEAK COFFEE AND SIDE TABLES**  
P 164 | 165



**ROZY COFFEE TABLE**  
P 151



**ROZY SIDE TABLE**  
P 142

## TABLES



**VOLTA DINING TABLE**  
P 62



**WICKED DINING TABLE**  
P 118



**SAM DINING TABLE**  
P 11 | 62



**NOA DINING TABLE**  
P 62





**DAVID DINING TABLE**  
P 82



**KODO DINING TABLE**  
P 33



**LEO DINING TABLE**  
P 73



**MAX DINING TABLE**  
P 73 | 108

**BENCHES**



**MATTEO DINING TABLE**  
P 130



**MATTEO BENCH**  
P 130

## TABLES



**RONDA BISTRO TABLE**  
P 108



**SPHERA BISTRO TABLE**  
P 108



**QUADRO BISTRO TABLE**  
P 108



**NIMES DINING TABLE LLOYD LOOM**  
P 164



**SAFI DINING TABLE SYNTHETIC**  
P 150





**TIKA LANTERN**  
P 99



**MORA LAMP**  
P 100



**MAYA LAMP**  
P 96



**IVO PLANT STAND**  
P 154



**LIGHT MY TABLE**  
P 99



**TOUNDRA RUG AND CLIFF RUG**  
P 74





## **Vincent Sheppard showroom**

Doornikserijksweg 193A  
8510 Bellegem - Belgium

On appointment only

## **Vincent Sheppard HQ**

Industriepark 5  
8587 Spiere - Belgium  
+32 56 46 11 11  
info@vincentsheppard.com  
www.vincentsheppard.com



