

BEDS _____

_____ &

SOFA _____

_____ BEDS

Vibieffe

SINCE 1968

_Our history



Vibieffe
SINCE 1968

Chi siamo

Who we are

_IT Vibieffe, azienda che produce poltrone e divani, nasce nel 1968 in una terra da sempre sinonimo di arredamento di alta qualità: la Brianza.

E oggi è una realtà conosciuta e consolidata anche internazionalmente.

Fin dalla sua fondazione, l'obiettivo che l'azienda si propone di perseguire è quello di realizzare elementi d'arredo – in particolare imbottiti come divani, poltrone e divani-letto, a cui si sono affiancati nel tempo complementi e proposte di sicura affidabilità, durata, piacevolezza estetica, grande versatilità e comodità. Comfort e design sono, infatti, i tratti distintivi delle creazioni Vibieffe nate dalla creatività di famosi architetti e designer del settore, firme conosciute nel panorama d'arredo che hanno saputo dare ai prodotti quel tocco di distinzione che fa la differenza.

Ma Vibieffe si contraddistingue non solo per la qualità dei suoi prodotti. Tra i valori aggiunti che hanno reso l'azienda di Lissone una realtà concreta ed affidabile vi è la grande esperienza ed abilità artigianale della manodopera di cui si avvale, tradotte con tecnologie ed attrezzature all'avanguardia che hanno permesso la sperimentazione anche di materiali innovativi e di lavorazioni alternative.

_EN Vibieffe, a company that manufactures armchairs and sofas, was set up in 1968 in an area that has always been considered home to high-quality furniture production: Brianza. Today it is an established and well-known company worldwide.

Since its foundation, the main purpose of the company has been the furniture manufacturing – it started with upholstered products such as sofas, armchairs, sofa beds and then the collection was completed with complements. All products are characterized by reliability, durability, aesthetic pleasure, great versatility and comfort.

Comfort and design are, indeed, the hallmarks of Vibieffe creations designed with the creativity of renowned architects, designers and leading companies in furnishing industry who add to the products a distinctive character that makes them unique.

Vibieffe doesn't stand out only for the quality of the products: among the added values that have made the company from Lissone solid and reliable there are wide experience and skilled craftsmanship supported by up-to-date technologies and equipment to test innovative materials and alternative processes.

_IT Il riposo è da sempre considerato uno dei fondamenti del benessere e dal momento che riposare è oggi più che mai sinonimo di dormire bene, la qualità del sonno è divenuta oggetto di veri e propri studi scientifici. E' ormai consuetudine dichiarare che la qualità delle nostre giornate dipende dalla qualità delle nostre notti.

Durante le ore di sonno, infatti, il corpo non solo si riposa e si rilassa, ma si rigenera e si ricarica nel vero senso della parola. Se un tempo, dormire veniva associato all'idea di oziosità ed improduttività, oggi è dimostrato che dal buon sonno dipende tutto: salute, rendimento, prestazioni, benessere e produttività.

Perché il sonno possa davvero essere ristoratore è, non solo necessario riposare in ambienti favorevoli e silenziosi, ma è indispensabile poterlo fare su letti dalle superfici ergonomicamente studiate, comodi ed accoglienti, pensati e realizzati per migliorare l'intera qualità della nostra vita.

Così i trasformabili Vibieffe, non sono solo binomio di estetica e funzione, ma sono oggetti comodi, versatili e pratici, imbottiti ogni volta ricercati ed eleganti che, all'occorrenza, sanno trasformarsi in comodissimi letti. Ampia ed articolata è infatti la proposta di modelli che con pochi e semplici movimenti diventano letti singoli o matrimoniali, inseribili in qualsiasi contesto abitativo ed utilizzabili anche quotidianamente. Una perfetta sintesi di comfort e design, di innovazione e qualità.

Riposare con noi

Relax with us

_EN Rest has always been considered a foundation of wellness. Considering that rest is more than ever the equivalent of sleep well, sleep quality has become subject of many scientific researches. It is now recognized that the quality of our days is affected by the quality of our nights.

During the hours of sleep, indeed, our body not only rests and relaxes, but it also regenerates and recharges itself. In the past sleeping was considered lazy and not productive, while today it is demonstrated that good sleep affects everything: health, efficiency, performance, well-being and productivity. In order to achieve a restorative sleep, it is necessary to rest in a relaxing and quiet environment, but it is also essential to lie on a bed with good ergonomic support, comfortable and welcoming, designed to improve our quality of life.

Considering this, Vibieffe convertible products are not only the combination of aesthetics and function, but they are also comfortable, versatile and practical, always refined and elegant upholstered furniture, able to transform into cosy beds. A wide range of models can be converted in single or double beds with a few simple movements, they suit any style and they can be used every day. A perfect mix of comfort and design, innovation and quality.



1
_made in Italy
_made in Italy



2
_tecnologie avanzate
_advanced technologies



3
_ricerca e sviluppo
_research and development



4
_sartorialità
_tailoring



5
_sicurezza e affidabilità
_solidity and reliability



6
_garanzie
_guarantees



7
_imbottiture ergonomiche
_ergonomic paddings



8
_ecosostenibilità
_environmental sustainability



9
_qualità dei rivestimenti
_cover quality

10
_vita attraverso gli spazi
_life through dimensions



10 motivi
per sceglierci
10 reasons to choose us



“Un uomo percorre il mondo in
cerca di ciò di cui ha bisogno e
torna a casa per trovarlo”

*“A man travels the world in search of what
he needs and returns home to find it”*

George Moore



NIGHT COLLECTION

LETTI
Beds

DIVANI LETTO
Sofa Beds

ACCESSORI LETTO
Night Complements

Vibieffe
SINCE 1968

CONTENUTO

CONTENT

INDICE 4 / 5

INDEX

LETTI 8 / 75

BEDS

DIVANI LETTO 78 / 165

SOFA BEDS

ACCESSORI LETTO 168 / 195

NIGHT COMPLEMENTS

LETTI e ACCESSORI LETTO

BEDS and NIGHT COMPLEMENTS

9₁₅ 5000_QUEEN



45₅₁ 5400_TANGRAM



17₂₅ 5050_ITALO



53₅₇ 5500_SOAP

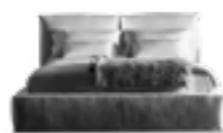

27₃₇ 5115_MODERN_EPOQUE



59₆₃ 5700_OPERA



37₄₃ 5300_OPEN



65₇₅ 5800_TUBE

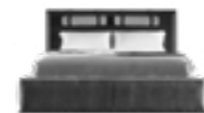

169₁₇₃ 1500_SWING



185₁₉₁ 9575_XENIA



175₁₇₇ 5050_ITALO



193₁₉₅ 9750_CONTRASTE



179₁₈₃ 5555_MODERN



79₈₇ 2505_DESIGUAL



89₉₇ 2750_SURPRISE



99₁₀₇ 2020_SQUADROLETTO



109₁₁₇ 2110_TANK



119₁₂₅ 2300_QUEEN



127₁₃₅ 2400_HAPPY



137₁₄₅ 2800_BEL AIR



147₁₅₁ 2900_OPEN



153₁₅₉ 3600_TANGRAM



161₁₆₅ 3700_GULP



DIVANI LETTO

SOFA BEDS

NIGHT *COLLECTION*

LETTI

BEDS



_IT Ricco di legami con la tradizione. I dettagli preziosi e l'elegante testata ne fanno un prodotto adatto per una casa raffinata.

_EN Tied to tradition. The precious details and the elegant headboard make it a product suitable for a refined home.

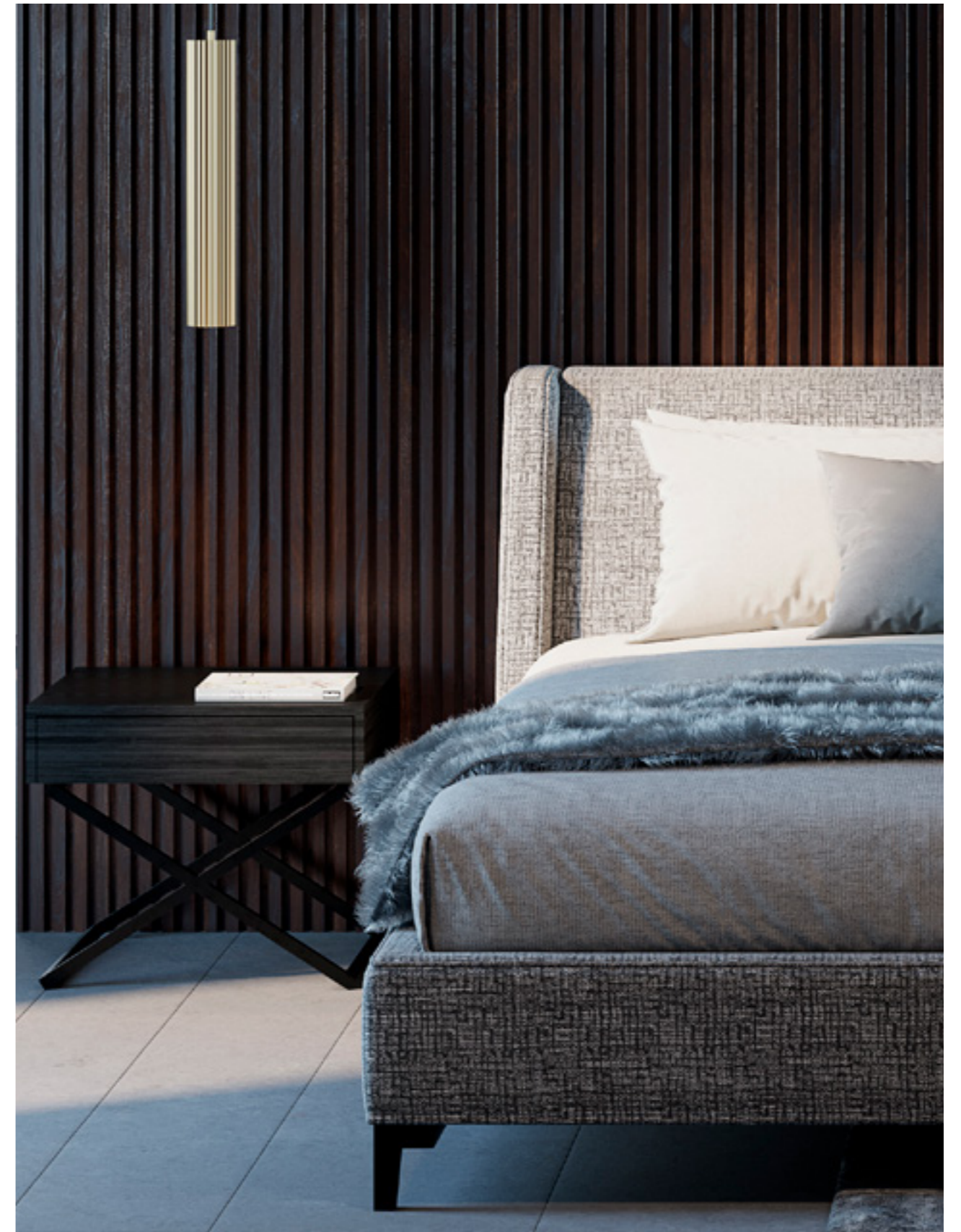



**_Letto matrimoniale con testata accogliente.
I pannelli laterali simili a paravento fanno di Queen un letto
da vivere nell'intimità.**

*_Double bed with cozy headboard. The side panels, similar to
dividers, envelop Queen bed in an intimate atmosphere.*





_I pannelli laterali ad ala ammorbidiscono le linee donando al letto Queen un aspetto avvolgente.

_Wing side panels soften the lines giving to Queen bed a welcoming look.

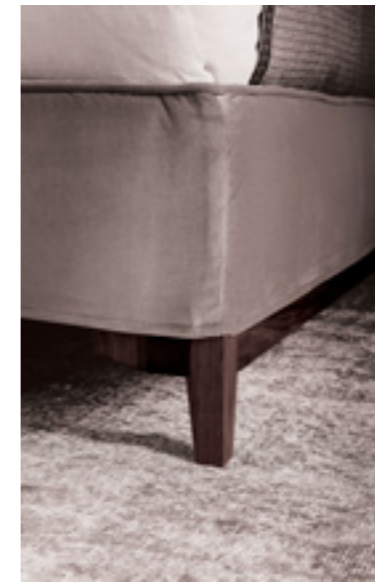

_Piedino e barra laterale in legno tinto moka.

_moka dyed wood feet and bar.



_Piedino e barra laterale in noce Canaletto.

_Canaletto walnut feet and bar.

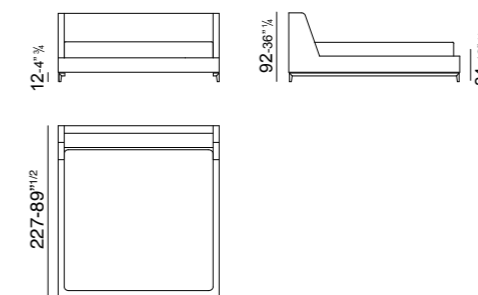

DIMENSIONI LETTI IN CM / BED DIMENSIONS IN CM	_cod 5000006	_cod 5000007	_cod 5000008	_cod 5000009
Ingombro letto / Bed size	166	176	196	206
Larghezza rete / Bedsprings width	150	160	180	190

_IT Italo è il prodotto dedicato a Italo Bucchella, fondatore di Vibieffe. Il prodotto racchiude in sé la storia e il futuro del design. Imponente ed elegante con le sue due testate asimmetriche e non, Italo_Letto è un prodotto semplice ma allo stesso tempo ricercato.

_EN Italo is the product dedicated to Italo Bucchella, founder of Vibieffe. The product embodies the past and the future of design. Italo_Bed is majestic and elegant, with two symmetrical or asymmetrical headboards. Its design is simple but sophisticated at the same time.

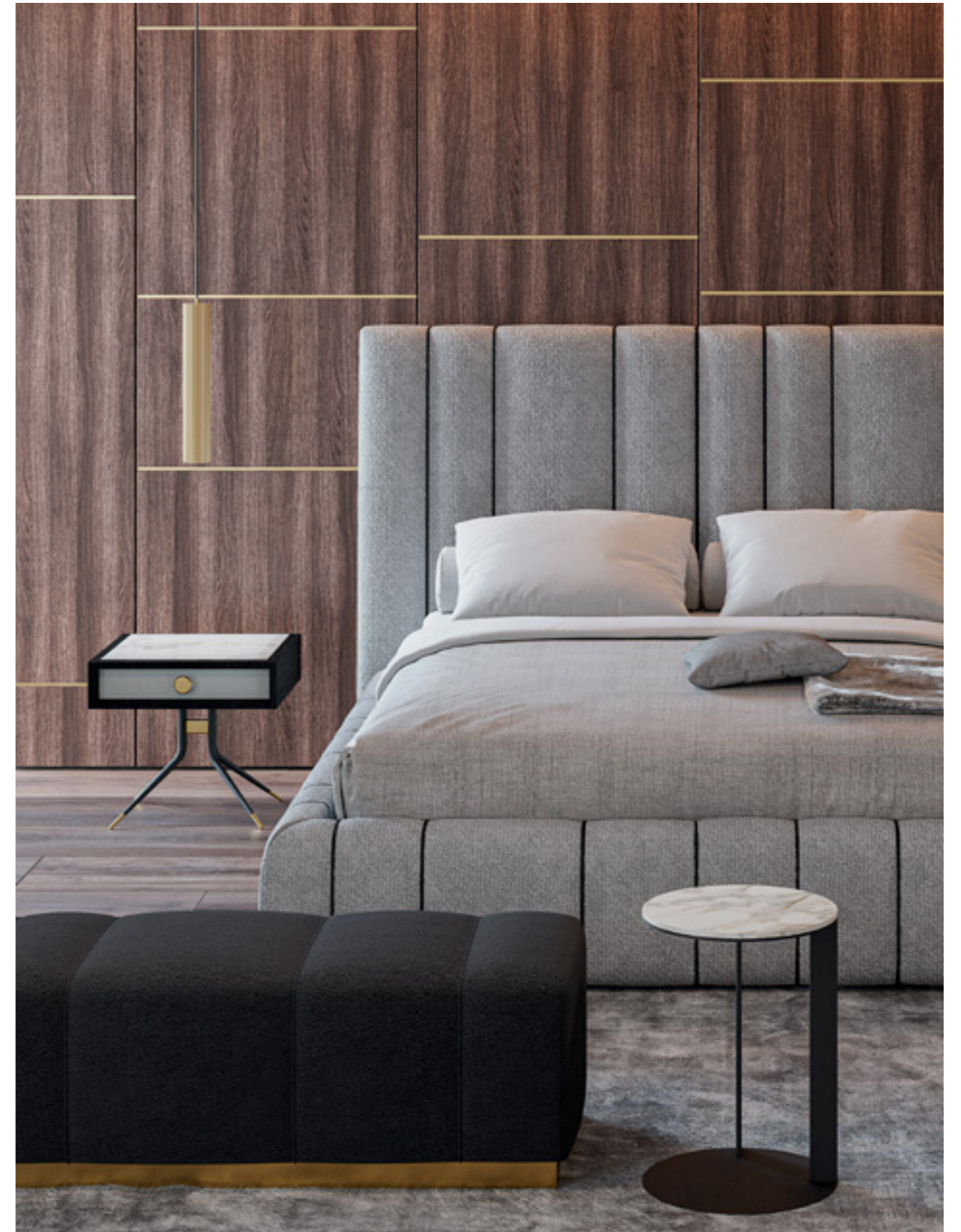



La modularità del letto della collezione Italo, si sviluppa attraverso l'accostamento delle due testate e la scelta della diversa dimensione della rete.

The modularity of Italo bed appears in the combination of the two headboards and in the availability of different frame sizes.



Letto con testata simmetrica stretta
Bed with narrow symmetrical headboard



Letto con testata asimmetrica sinistra
Bed with left asymmetrical headboard



Letto con testata simmetrica larga
Bed with wide symmetrical headboard



Letto con testata asimmetrica destra
Bed with right asymmetrical headboard





_Un profilo nero sottolinea la trapuntatura asimmetrica e meglio definisce il disegno che caratterizza il prodotto.

_A black piping highlights the asymmetrical quilting and defines the design of the product.

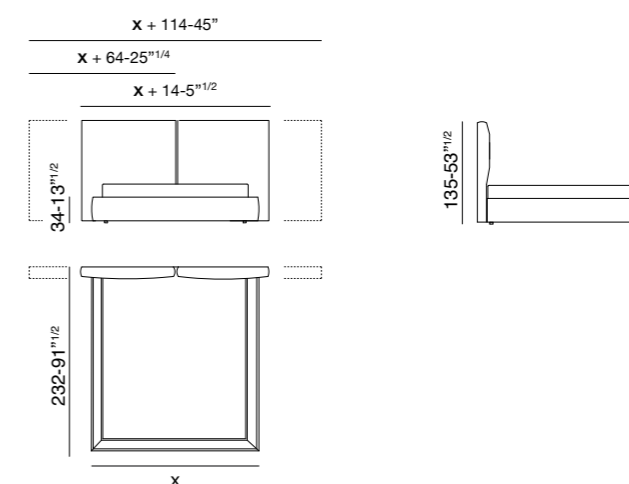

SU RICHIESTA /
ON REQUEST

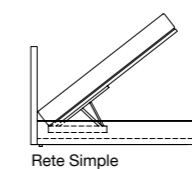

Rete Simple

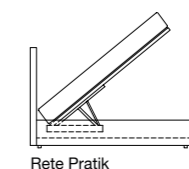

Rete Pratik

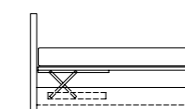

DIMENSIONI LETTI IN CM / BED DIMENSIONS IN CM

	_cod_50500005	_cod_50500006	_cod_50500007	_cod_50500008
Ingombro letto / Bed size	175	185	205	215
Larghezza rete / Bedsprings width	150	160	180	190

5115_MODERN_EPOQUE

_IT Nella versione letto, Modern_Epoque e Modern si fondono nello stesso prodotto espresso con caratteri diversi. Si raccontano in maniera versatile per differenti modi del vivere.

_EN In the bed version, Modern_Epoque and Modern blend in the same product that is represented with different features. Their versatility makes them suitable for different lifestyles.

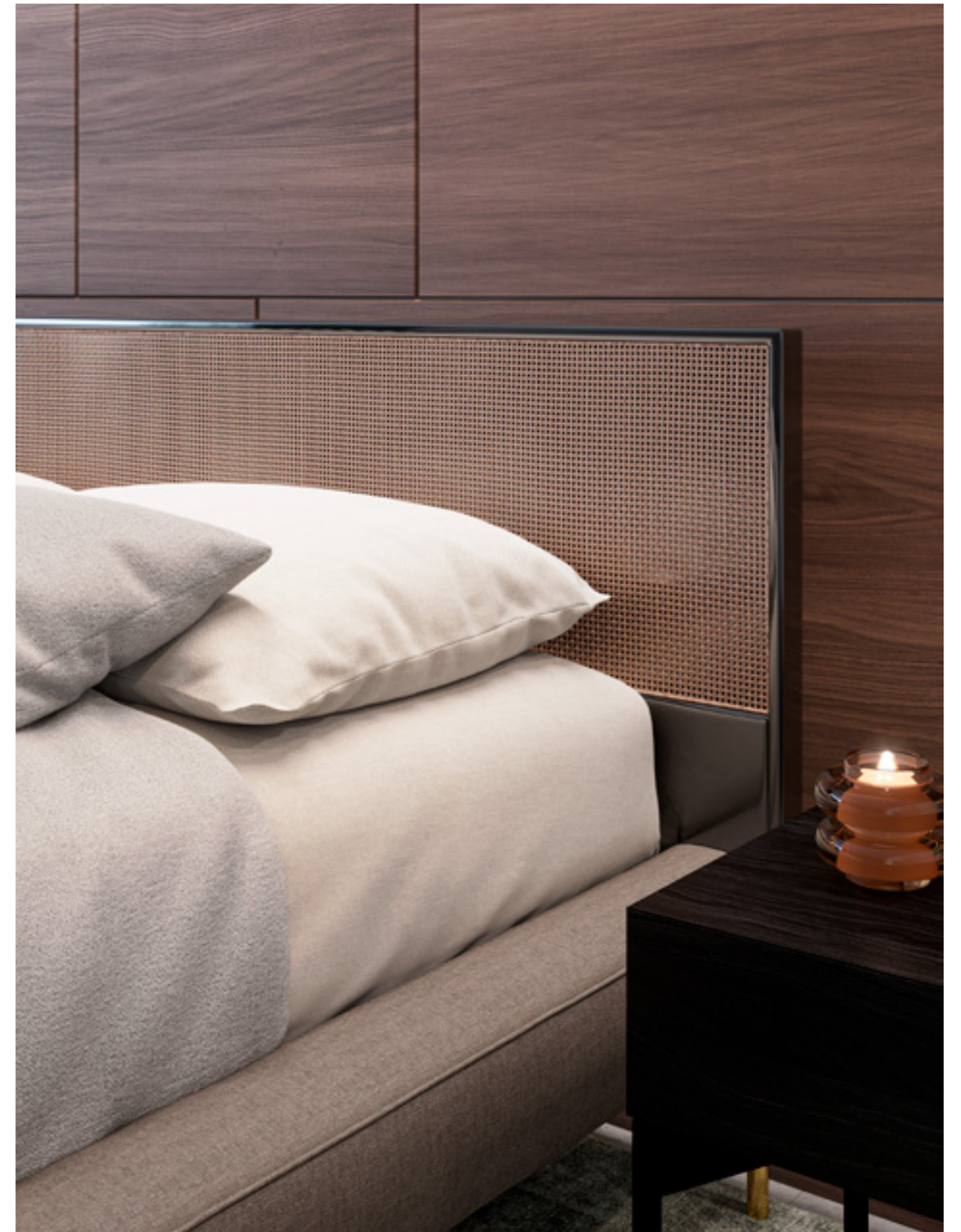





_La testata del letto Modern_Epoque in frassino laccato nero lucido o noce Canaletto con inserto in paglia di Vienna, di sicuro effetto estetico, assume un forte segno di stile ed eleganza che predominano sulla funzione.

_The Viennese cane insert within the polished black lacquered ash or Canaletto walnut headboard of Modern_Epoque enhances the aesthetic effect that triumphs over function with its unique style and elegance.



_Il letto rappresenta il carattere della persona e dell'ambiente che lo contiene. La testata del letto Modern_Epoque, in versione totalmente imbottita, si manifesta in tutta la sua raffinata semplicità.

_The bed embodies the character of the individual and the personality of the room. The upholstered version of Modern_Epoque bed reveals its refined simplicity.





_Piedi con finitura nickel nero e puntale ottone o totalmente nickel nero.

_Feet in black nickel finish or with brass tips.

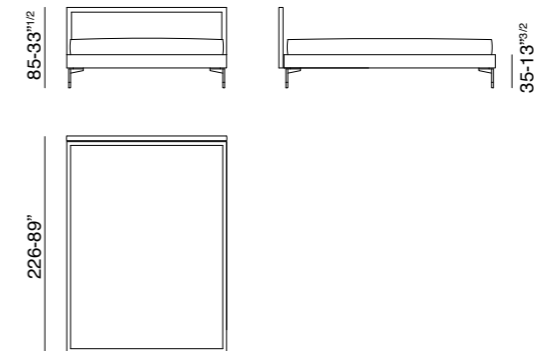

DIMENSIONI LETTI IN CM / BED DIMENSIONS IN CM

	_cod 5115009 _cod 5115010	_cod 5115011 _cod 5115012	_cod 5115013 _cod 5115014	_cod 5115015 _cod 5115016
Ingombro letto / Bed size	166	176	196	206
Larghezza rete / Bedsprings width	150	160	180	190

_IT Mood sartoriale con dettagli esclusivi e raffinati mixati ad arte. Comfort e praticità sono le caratteristiche che rendono Open un letto dal relax personalizzabile.

_EN Sartorial design with exclusive and refined details that are artfully combined. Comfort and practicality are the hallmarks that provide Open with a personalized relaxation.





_Open nasce da un progetto che combina il massimo della funzione attraverso i poggiatesta ad inclinazione regolabile, con proporzioni calibrate.

_Open was conceived from a project that combines the utmost functionality of the adjustable headrest with balanced proportions.



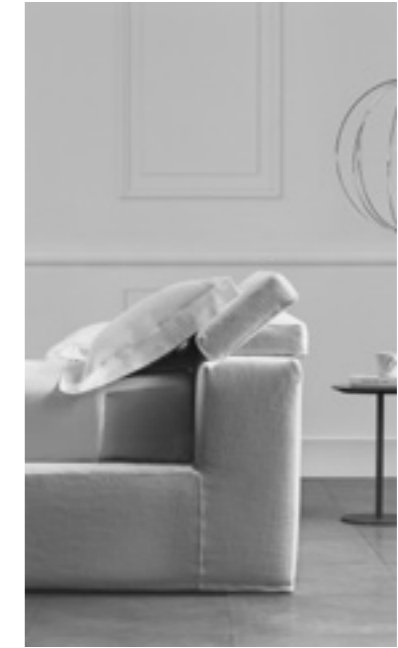

_La ricerca del comfort e del relax passa attraverso un pratico schienale a inclinazione variabile.

_Comfort and relaxation are embodied by a practical headboard with adjustable mechanism

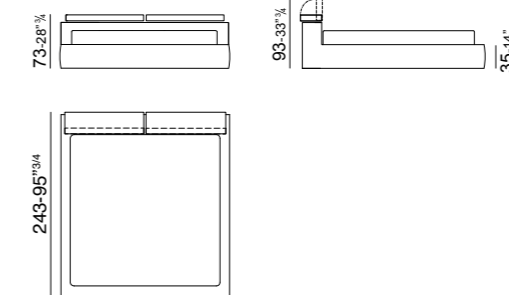

SU RICHIESTA /
ON REQUEST

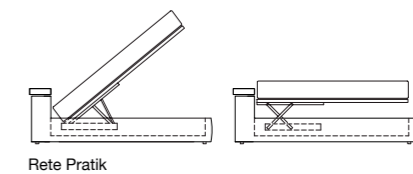
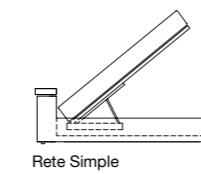

DIMENSIONI LETTI IN CM / BED DIMENSIONS IN CM	_cod_5300005	_cod_5300006	_cod_5300007	_cod_5300008
Ingombro letto / Bed size	176	186	206	216
Larghezza rete / Bedsprings width	150	160	180	190

_IT Un profilo che ne sottolinea l'eleganza, un rigore segnato e definito dalle impunture sulla testata.

_EN A flat band highlights its elegance, while its rigor is marked and defined by the tufted headboard.

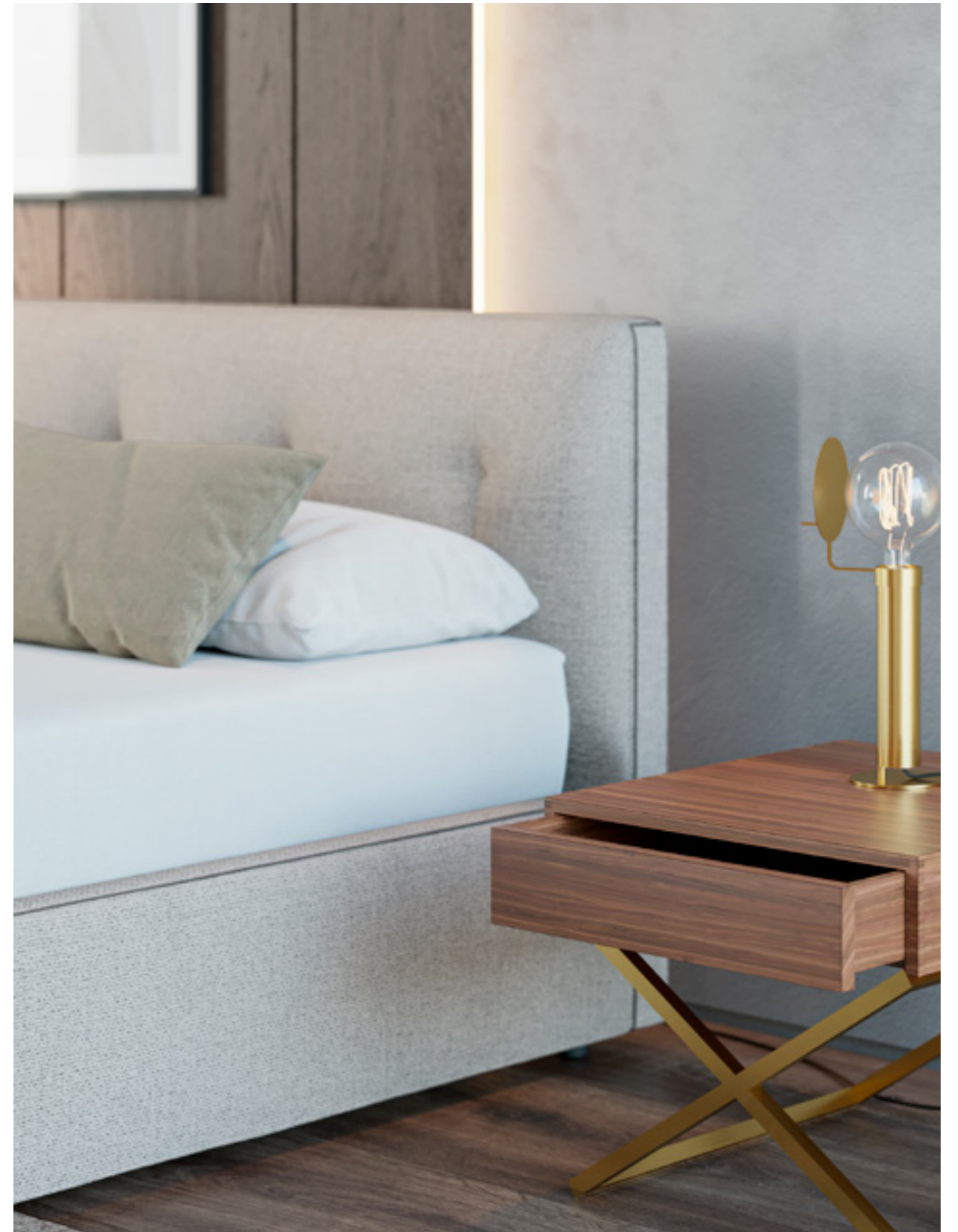





_Letto con basamento a terra nella versione con e senza contenitore. La testata sagomata è caratterizzata da una serie di impunture che ne definiscono il volume e modellano la superficie. Letto completamente sfoderabile.

_Bed with frame sitting on the floor with or without storage. The contoured headboard is characterized by the tufting that defines its volume and shapes the surface. Fully removable covers.



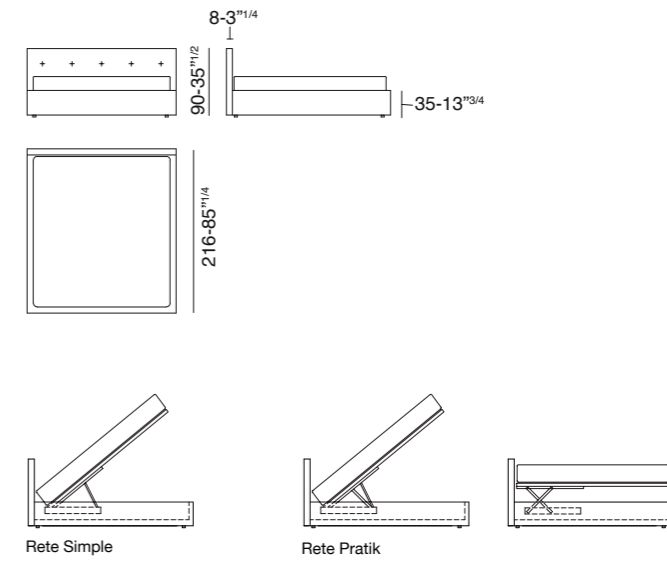

SU RICHIESTA /
ON REQUEST

Rete Simple

Rete Pratik

DIMENSIONI LETTI IN CM / BED DIMENSIONS IN CM

	cod 5400005	cod 5400006	cod 5400007	cod 5400008
Ingombro letto / Bed size	166	176	196	206
Larghezza rete / Bedsprings width	150	160	180	190

_IT Le linee avvolgenti e morbide della testata trasmettono un'immagine calda ed accogliente.

_EN *The enveloping and soft lines of the headboard convey in a cozy and warm feeling.*

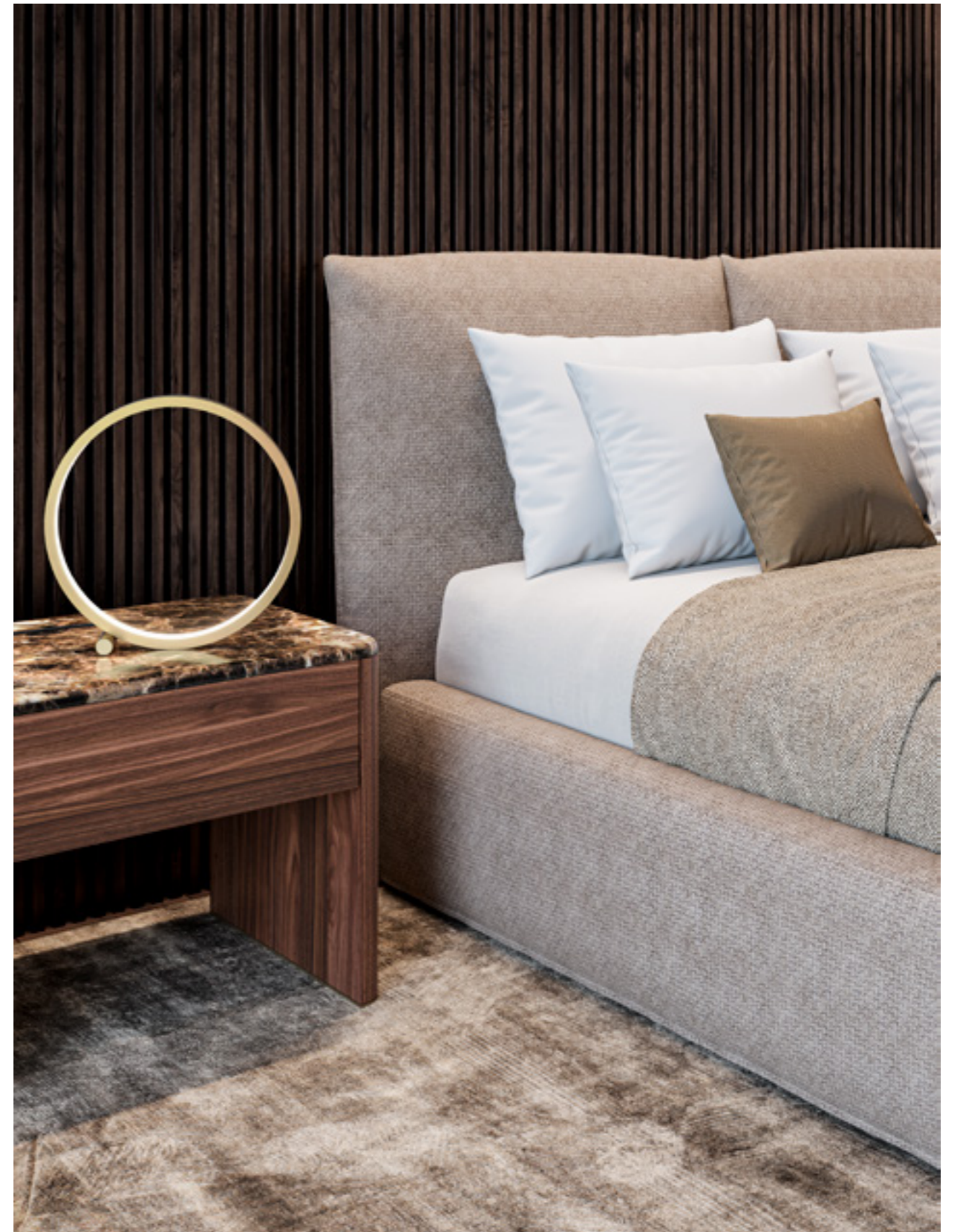





_La morbidezza della confezione della testata e la sua forma avvolgente più larga del giro letto, danno vita a una linea ricca volta ad esaltarne l'architettura stessa del letto.

_The soft headboard and its enveloping shape, wider than the bed frame, result in a rich line aimed at enhancing the architecture of the bed itself.

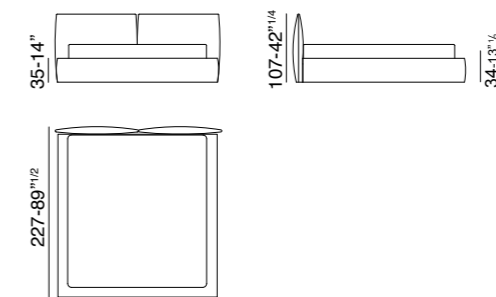

SU RICHIESTA /
ON REQUEST

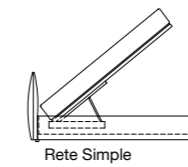

Rete Simple

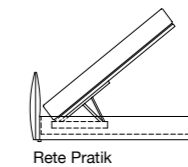

Rete Pratik

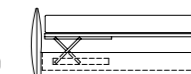

DIMENSIONI LETTI IN CM / BED DIMENSIONS IN CM

	_cod_5500005	_cod_5500006	_cod_5300007	_cod_5500008
Ingombro letto / Bed size	184	194	214	224
Larghezza rete / Bedsprings width	150	160	180	190

_IT Essenza materica e al tempo stesso poetica, per un effetto di grande impatto visivo ed emotivo. Il capitonné sulla testata esalta l'artigianalità e regala suggestioni romantiche.

_EN Material and poetic expression at the same time, a great visual and emotional impact. The tufted headboard highlights the skilled craftsmanship and offers romantic suggestions.



_Un'accurata esecuzione artigianale della testata, con un raffinato utilizzo della pelle lavorata a "capitoné", assieme alla leggerezza di piedini aerei, rendono Opera un oggetto sospeso tra passato e futuro.

_The accurate craftsmanship of the headboard with tufted leather and the lightness of the airy feet make Opera an object suspended between past and future.





_Piedini in faggio tinto moka.
_feet in moka dyed beech.



_Piedini in faggio tinto noce.
_feet in walnut dyed beech.



_Lavorazione testata capitonné
_tufted headboard

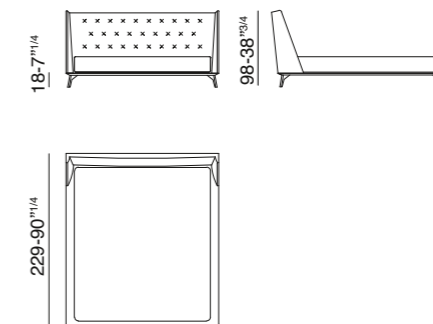
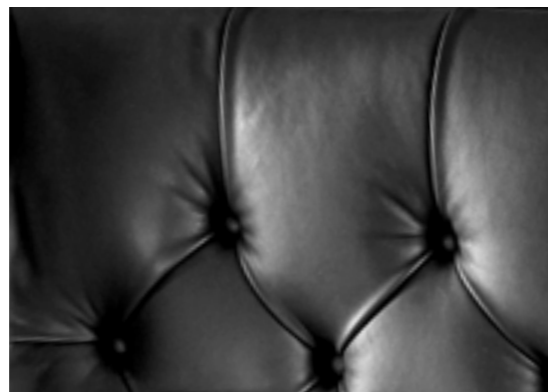

DIMENSIONI LETTI IN CM / BED DIMENSIONS IN CM

	cod 5700005	cod 5700006	cod 5700007	cod 5700008
Ingombro letto / Bed size	172	182	202	212
Larghezza rete / Bedsprings width	150	160	180	190

_IT Fascino, originalità e innovazione ne sono le caratteristiche. Tube con la sua testata completamente in cuoio, arricchita da rulli regolabili, riesce a personalizzare ogni progetto.

_EN Charm, originality and innovation are its characteristics. Tube can personalize each project with its saddle leather headboard, enriched with adjustable roll cushions.

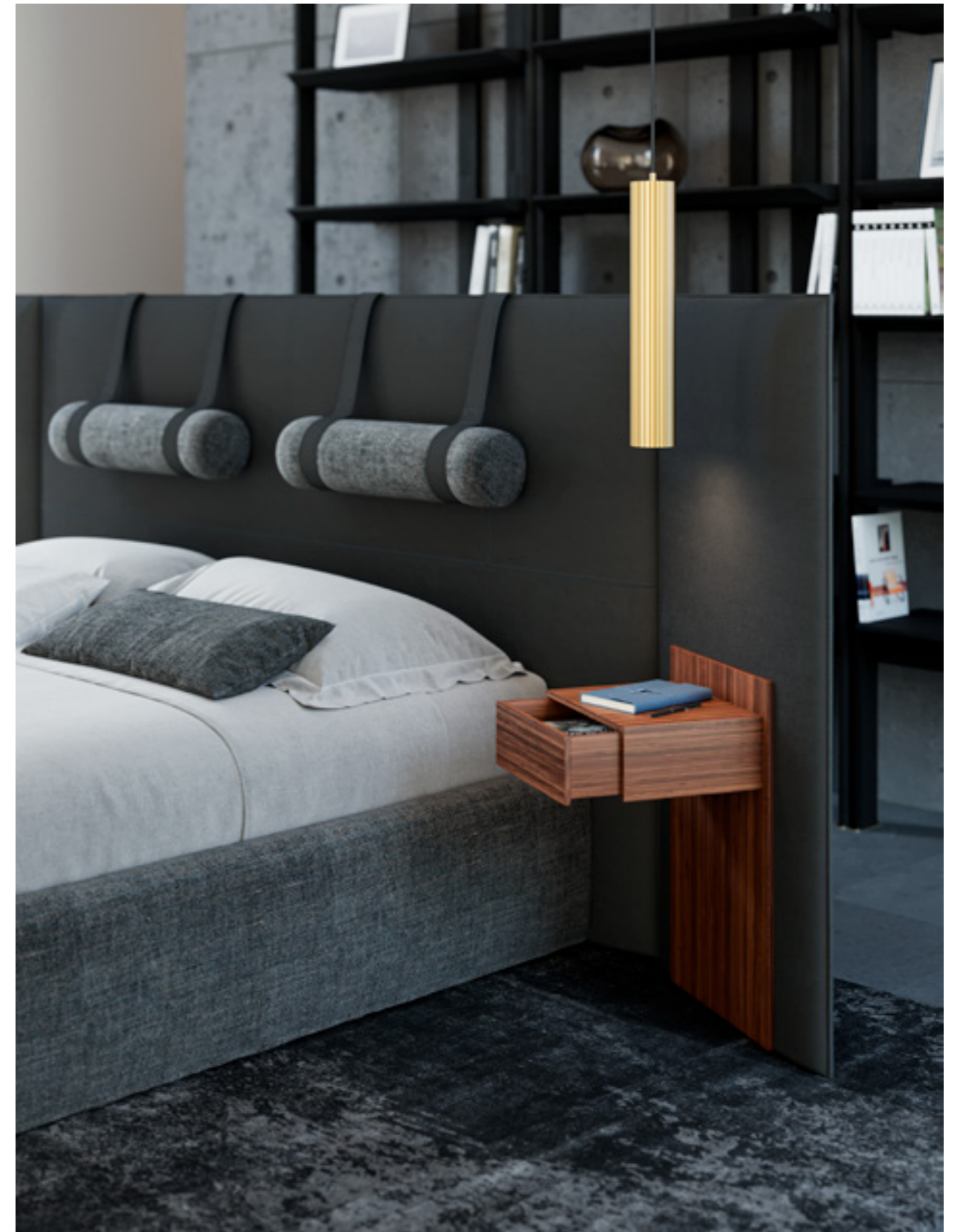





_I pannelli laterali incernierati alla testata si chiudono a creare uno spazio raccolto. I rulli regolabili permettono di godere del proprio relax.

_Side panels hinged to the headboard can be closed to create a snug space. The adjustable roll cushions allow to enjoy your own relaxation.



**_I pannelli ad ala laterali si possono integrare con comodini in legno.
Il comodino, in due finiture moka e Canaletto, è predisposto per essere cablato elettricamente.**

*_The side wing panels can be completed with wooden night tables.
The night table in two finishes, moka and Canaletto walnut, is suitable for electrical wiring*







_L'elegante testata in cuoio è corredata da due rulli sospesi e regolabili fino ad ottenere la propria comodità.

_The refined headrest in saddle leather includes two suspended roll cushions that can be adjusted to find your own comfort.

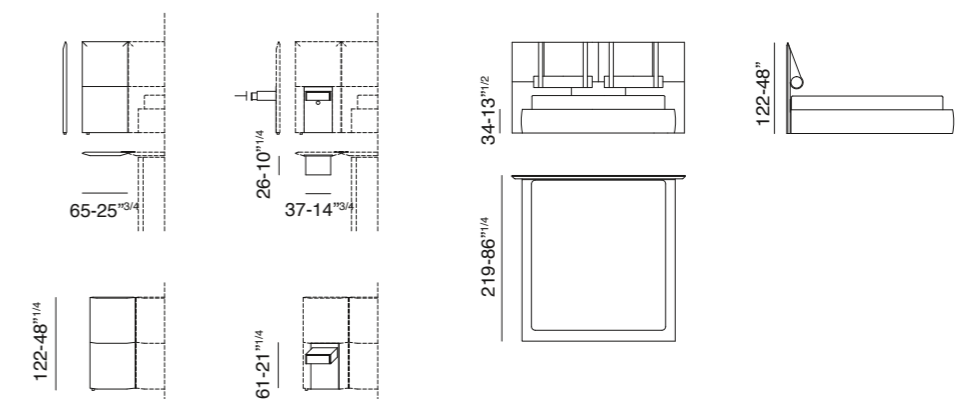

DIMENSIONI LETTI IN CM / BED DIMENSIONS IN CM

	_cod 5800008	_cod 5800009	_cod 5800010	_cod 5800011
Ingombro letto / Bed size	181	191	211	221
Larghezza rete / Bedsprings width	150	160	180	190

NIGHT *COLLECTION*

DIVANI LETTO

SOFA BEDS



_IT Quando la semplicità di un disegno e la funzionalità della tecnica interpretano le nostre semplici necessità.

_EN The simplicity of design and the functionality of technique meet our simple needs.





_Desigual è un divano letto o meglio sono due materassi che diventano divano letto. La sua base e lo schienale, con un semplice movimento, si allineano per diventare letto. La meccanica a compasso non necessita, nell'apertura, di distanziare il divano dal muro.

_Desigual is a sofa bed or rather two mattresses that converts to a sofa bed. Its base and backrest are aligned with a simple movement to turn into a bed. The compass mechanism doesn't require to move the sofa away from the wall when opening.







La costruzione delle imbottiture di seduta e schienale, che diventano materasso, consentono un adeguato relax per un sonno ristoratore.

The padding of the seat and the backrest, which become a mattress, provides adequate relaxation for a restful sleep.

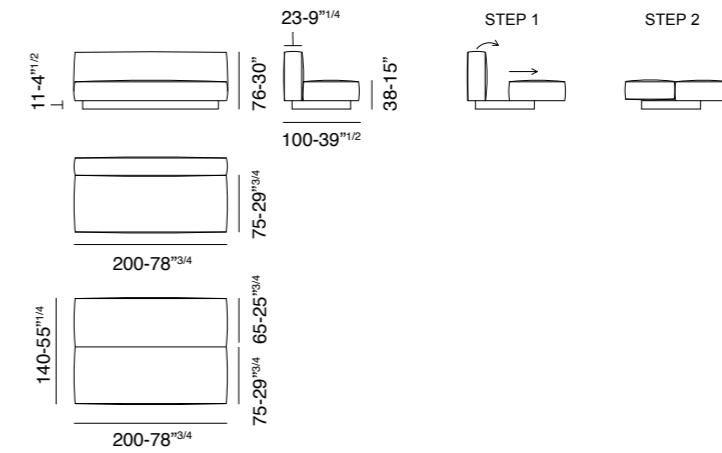

DIMENSIONI DIVANO LETTO IN CM / SOFA BED DIMENSIONS IN CM

Ingombro divano letto / Sofa bed size	200
Larghezza rete / Bedsprings width	140

_cod 25050001

_IT Il concept progettuale innovativo, dove la funzione si modifica, interpreta il vivere quotidiano con un'estetica di alta gamma. Surprise si articola su due basi di diverse dimensioni nella versione sia pouf a letto o fisso.

_EN *The innovative design concept, where function changes, suits everyday life with high-end aesthetics. Surprise comes in two different sizes both in the folding ottoman sleeper bed and in the fixed ottoman version.*







_La versatilità di Surprise sta nell'essenzialità del disegno che ne permette la facilità di un suo inserimento in ambienti diversi. Il comodo schienale pesante, liberamente posizionabile, consente a ciascuno di trovare il proprio massimo comfort.

_The versatility of Surprise lies in its essential design that makes it suitable in different environments. The comfortable weighted back cushion, to be freely positioned, allows everyone to find their own comfort.





_La sua meccanica è contenuta nella base sotto un piano-cuscino sollevabile. Il materasso in poliuretano espanso all'interno della rete misura cm. 160x190.

_Its mechanism is inside the base under a lifting cushion. The size of the polyurethane foam mattress on the bedsprings is cm 160x190.

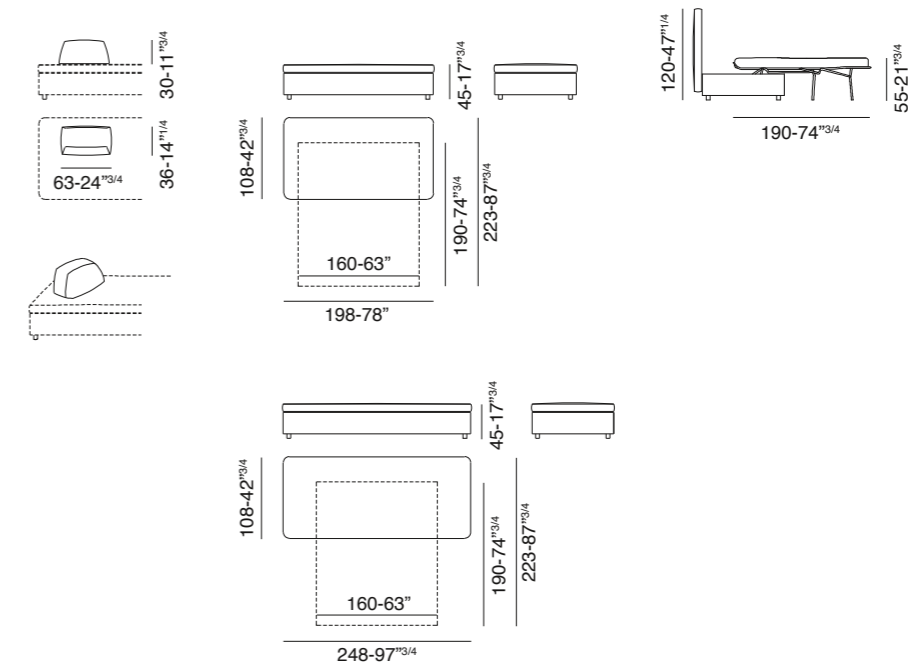

DIMENSIONI POUFF LETTO IN CM / SLEEPER OTTOMAN DIMENSIONS IN CM

	_cod 2750001	_cod 2750002
Ingombro pouff letto / Sleeper ottoman size	198	248
Larghezza rete / Bedsprings width	160	160

_IT Comodità, accoglienza e versatilità interpretate da varianti di braccioli per esigenze e gusti diversi.

_EN Comfort, coziness and versatility are represented by a wide variety of armrests to satisfy different tastes and needs.







_Spalla laterale
_Upholstered side panel



_Bracciolo cm 7
_Arm cm 7



_Bracciolo cm 12
_Arm cm 12



_Bracciolo cm 15
_Arm cm 15



_Bracciolo cm 20
_Arm cm 20

_La diversa larghezza e forma dei braccioli permettono di caratterizzare l'aspetto di Squadroletto, ottimizzando così lo spazio a disposizione.

_The different widths and the armrest shapes allow to personalize Squadroletto according to the available space.



_I diversi materiali proposti per i materassi garantiscono la scelta personalizzata per il vostro comfort.

_ The mattresses are available in different materials to suit any comfort needs.



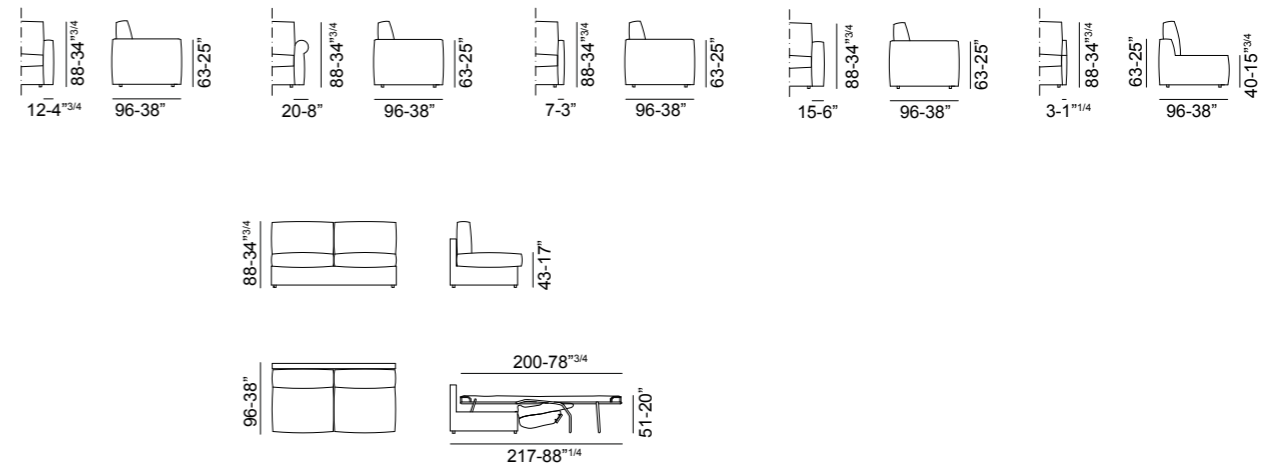

DIMENSIONI DIVANO LETTO IN CM / SOFA BED DIMENSIONS IN CM

	_cod/2020014	_cod/2020011	_cod/2020012	_cod/2020013
Ingombro divano letto / Sofa bed size	97	147	167	187
Larghezza rete / Bedsprings width	70	120	140	160

_IT La più pura interpretazione del concetto del design per un oggetto da vivere, da guardare e da ricordare.

_EN *The purest interpretation of design for a product to live, stare and remember.*







_Il divano letto Tank ha una sua personalità con un volume ben definito lateralmente. Questo spazio si può completare con due elementi terminali, pouff o tavolino-contenitore, entrambi funzionali allo spazio e montati su ruote.

_ Tank sofa bed has its own personality with a clear side volume. This space can be completed with end elements: ottoman and small table with storage, both functional and on wheels.



_Il divano lateralmente può essere completato anche con un bracciolo avvolgente, o con pouff o con contenitore laterale indipendente, che può essere utilizzato per accogliere gli accessori notte e come piano di appoggio.

_The sofa can also be completed on the side with an enveloping armrest, an ottoman or a separate container for night accessories and as a support surface.

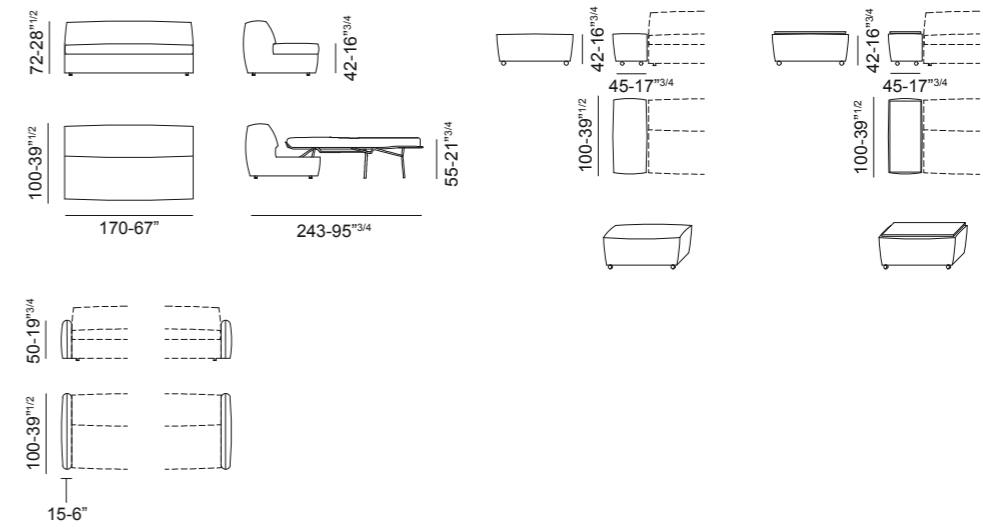

DIMENSIONI DIVANO LETTO IN CM / SOFA BED DIMENSIONS IN CM

	cod 2110001	cod 2110002	cod 2110003
Ingombro divano letto / Sofa bed size	150	170	190
Larghezza rete / Bedsprings width	120	140	160

_IT Una scelta di sapore volutamente più tradizionale per una proposta dalla funzionalità senza tempo.

_EN A proposal that is intended to be more traditional, with timeless functionality.





_Rendono particolarmente confortevole il divano letto Queen i soffici poggiatesta adagiati sullo schienale. Il carattere ben preciso di questo divano passa attraverso la barra di legno presente in due differenti finiture: legno tinto moka o noce Canaletto.

_The soft lumbar cushions make Queen sofa bed particularly comfortable. The personality of this sofa is also expressed through the wooden bar available in two finishes: moka stained wood or Canaletto walnut.





__Piedini e barra laterale in legno tinto moka.
__feet and lateral bar in moka stained wood.



__Piedini e barra laterale in noce Canaletto.
__feet and lateral bar in Canaletto walnut.

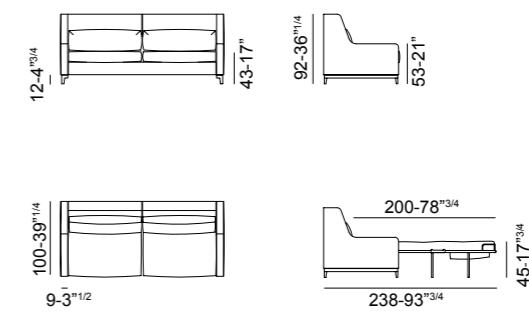

DIMENSIONI DIVANO LETTO IN CM / SOFA BED DIMENSIONS IN CM

	_cod 2300001	_cod 2300002	_cod 2300003
Ingombro divano letto / Sofa bed size	157	177	197
Larghezza rete / Bedsprings width	120	140	160

_IT Forma, funzione e purezza di volumi per un modello dalla ricercata semplicità. Segni particolari: i piedini in metallo brunito.

_EN Its shape, function and clean-cut volumes give this model a refined simplicity. Distinguishing marks: burnished metal feet.









_La forma rigorosa della struttura accoglie confortevoli cuscini schienale da rimuovere per sviluppare la rete e configurare il divano per la notte. Il piede in metallo brunito disegna l'angolo del letto Happy e ne esalta la leggerezza.

_The rigorous shape of the frame embraces comfortable back cushions to be removed to open the bed at night. The burnished metal feet outline the corner of Happy sofa bed and enhance its lightness.



*_piedino in metallo brunito
_burnished metal feet*

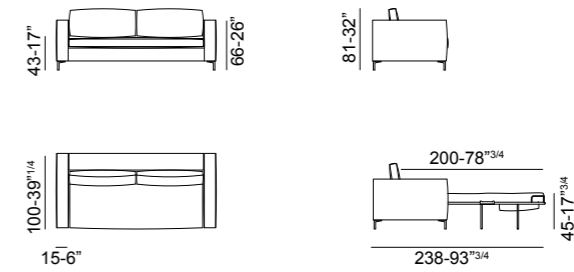

DIMENSIONI DIVANO LETTO IN CM / SOFA BED DIMENSIONS IN CM

	_cod 2400001	_cod 2400002	_cod 2400003
Ingombro divano letto / Sofa bed size	168	188	208
Larghezza rete / Bedsprings width	120	140	160

_IT Una proposta dall'estrema accoglienza e praticità d'uso. Il valore aggiunto: la penisola con vano contenitore.

_EN An extremely cozy and functional product. Its added value is represented by the chaise longue with storage.









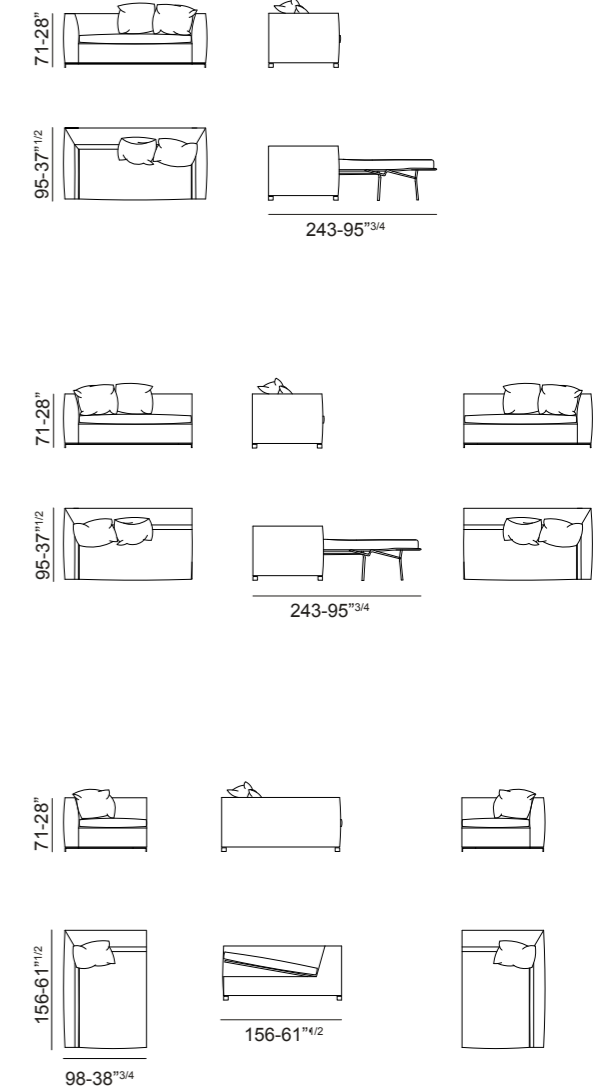

pedino in metallo brunito
burnished metal feet

DIMENSIONI DIVANO LETTO IN CM / SOFA BED DIMENSIONS IN CM	_cod 2800001	_cod 2800002	_cod 2800003	_cod 2800004 _cod 2800005	_cod 2800006 _cod 2800007	_cod 2800008 _cod 2800009
Ingombro divano letto / Sofa bed size	186	206	226	168	188	208
Larghezza rete / Bedsprings width	120	140	160	120	140	160

Divano letto / Sofa bed

Divano letto con 1 bracciolo
 Sofa bed with 1 arm

_IT Esteticamente elegante, il divano letto Open è doppiamente funzionale, sia per il comodo letto, sia per il confortevole schienale con poggiatesta.

_EN Aesthetically elegant, Open sofa bed is also extremely functional for the comfortable bed and backrest with headrest







_Rigorous e formale diventa estremamente accogliente con lo schienale a regolazione variabile. I piedi cilindrici bruniti nella loro estrema semplicità esaltano la forma di Open.

_Rigorous and formal, while the adjustable headrest makes it very welcoming. The cylindrical feet in burnished metal, in its extreme simplicity, enhance the shape of Open.

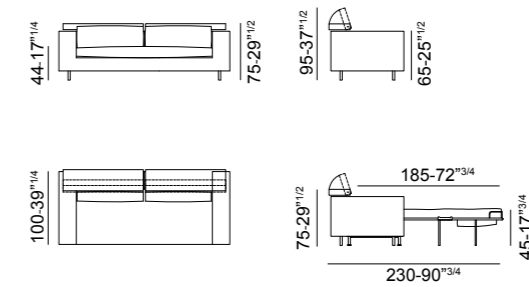

DIMENSIONI DIVANO LETTO IN CM / SOFA BED DIMENSIONS IN CM		_cod 2900001	_cod 2900002	_cod 2900003
Ingombro divano letto / Sofa bed size		186	206	226
Larghezza rete / Bedsprings width		120	140	160

_IT Profili in contrasto ne disegnano i contorni regalando vivaci note di colore, accanto ad una morbidezza estrema.

_EN Flat bands in contrasting colour outline the shape with an intense touch, combined with extreme softness.







_Divano letto curato nei particolari e ricco di dettagli. Disinvolto nell'aspetto, con tanti cuscini schienali dotati di un comodo rullo di supporto. I profili, a scelta in contrasto, ingentiliscono la struttura lineare.

_A sofa bed designed with great attention and rich in detail. Casual in its appearance, it includes many back cushions with a comfortable support roll. The flat bands, optionally in contrasting colour, refine the linear shape.

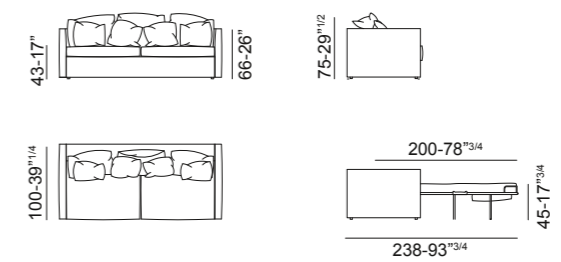

DIMENSIONI DIVANO LETTO IN CM / SOFA BED DIMENSIONS IN CM

	_cod 3600001	_cod 3600002	_cod 3600003
Ingombro divano letto / Sofa bed size	157	177	197
Larghezza rete / Bedsprings width	120	140	160

_IT Divano letto personalizzabile nella sua semplicità. Di facile e veloce uso sia come letto singolo sia, all'occorrenza, nell'opzione doppio letto estraibile.

_EN Sofa bed to be personalized in its simplicity. Quick and easy to use as single bed and also as double bed with pull-out mechanism.





_Pratico e veloce da trasformare da divano di soggiorno a letto singolo. A richiesta è previsto l'inserimento di un comodo letto estraibile e allineabile.

_Practical and quick to convert from a living room sofa to a single bed. Additional pull-out bed available upon request.

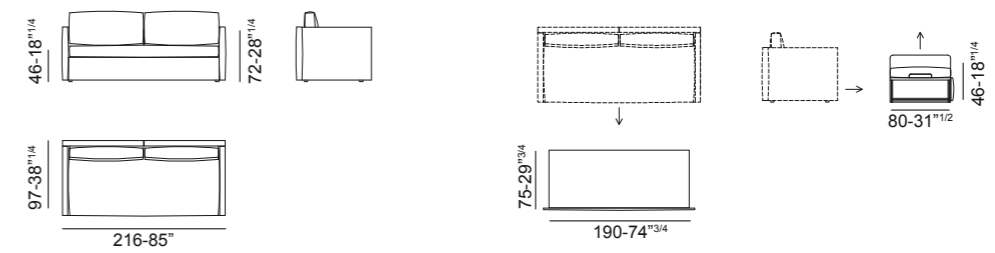

DIMENSIONI DIVANO LETTO IN CM / SOFA BED DIMENSIONS IN CM

	_cod.3700008	_cod.3700011
Ingombro divano letto / Sofa bed size	218	190
Larghezza rete / Bedsprings width	90	80

NIGHT COLLECTION

ACCESSORI LETTO

NIGHT COMPLEMENTS

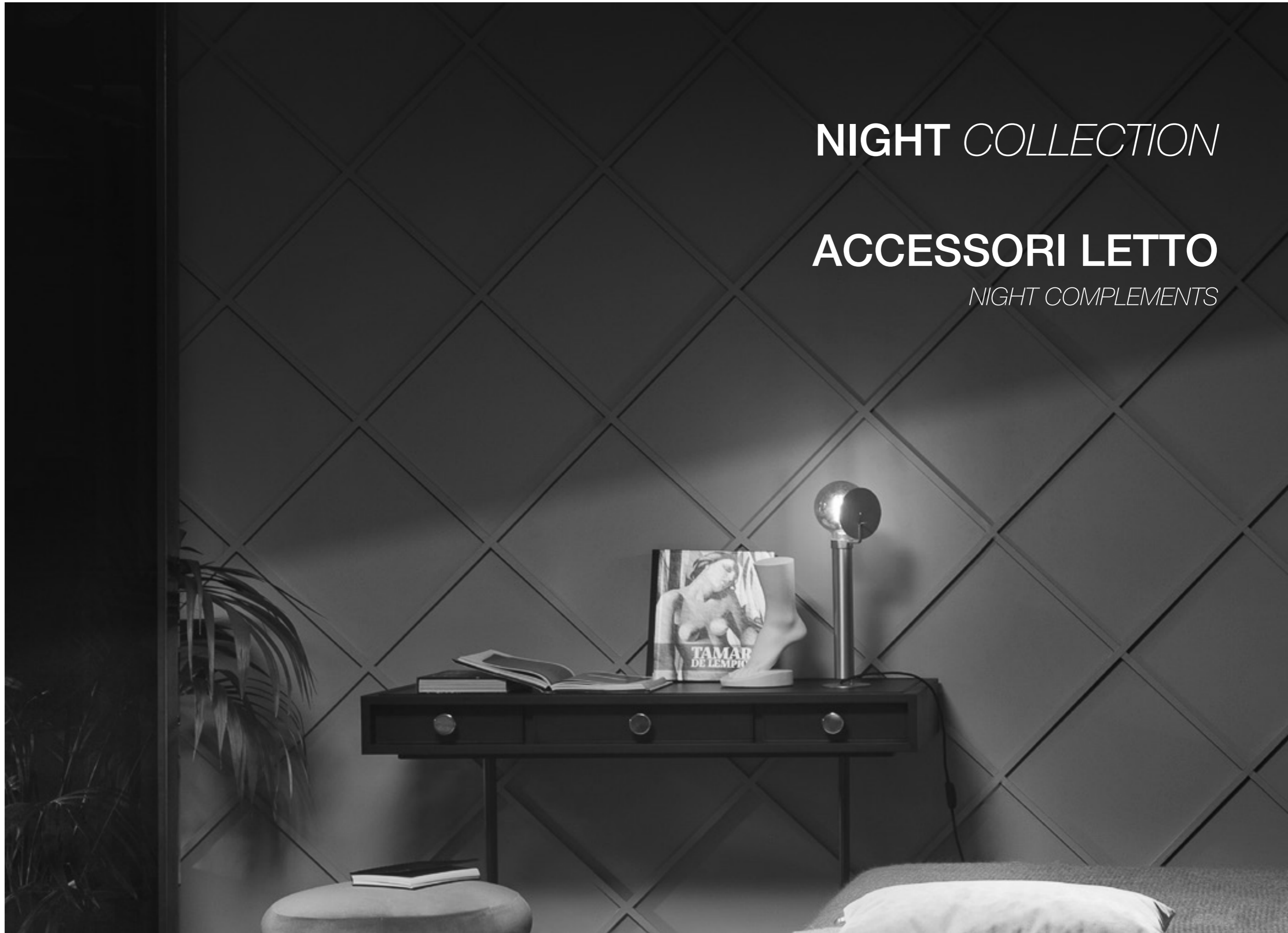

_IT Swing è la “memoria” della collezione: nelle sue forme riscopriamo la classicità e la memoria interpretate in chiave moderna. La collezione è estremamente ricca e si sviluppa su una struttura conificata delle gambe. Il comodino come oggetto segreto dove riporre i nostri sogni. Discreto, elegante e funzionale definisce lo spazio attorno al letto. Lo accompagnano Scrivitoio, Toilette e Panca.

_EN Swing represents the “memory” of the collection: classical shapes reinvented with a modern twist. Swing collection is extremely rich in elements, whose structure is developed on cone-shaped legs. The night table is the secret place to give shelter to our dreams. Discreet, elegant and functional, it defines the space around the bed. The same line includes the desk, the vanity and the bench.





_Swing_Toilette interpreta l'essenzialità e la leggerezza della forma: il sottile piano in marmo, la struttura in ottone con specchio e l'esile struttura delle gambe danno alla toilette una propria spiccata identità.

_Swing_Vanity embodies simplicity and lightness in shape: the thin marble top, the mirror with brass frame and the slender legs mark a distinctive personality.





**_Scrittoio in legno nero carbone o noce Canaletto
Piano e cassetti in cuoio**

*_Desk in black charcoal wood or Canaletto walnut
Top and drawers in saddle leather*



**_Toilette in legno nero carbone o noce Canaletto
e piano in marmi vari**

*_Vanity in black charcoal wood or Canaletto walnut
Top in different marbles*



**_Comodino in legno nero carbone o noce Canaletto
e piano in marmi vari**

*_Night table in black charcoal wood or Canaletto walnut
Top in different marbles*



_Panca con gambe in metallo brunito e puntale in ottone

_Bench with burnished metal legs and brass tips

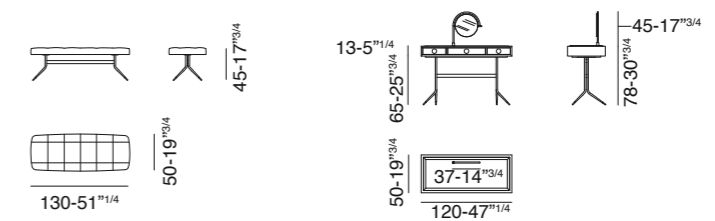
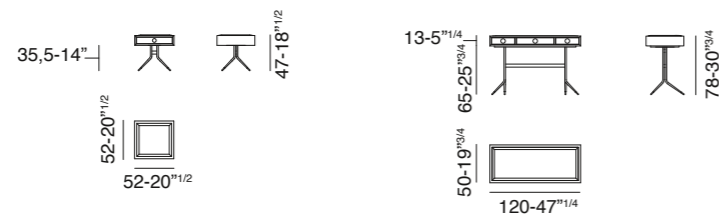

_IT Mestoso nella sua semplice geometria,
rigoroso ma allo stesso tempo discreto.
Riempie lo spazio e lo arricchisce di funzioni.

*_EN Majestic in its simple geometry, rigorous but
discreet at the same time. It fills the space enhancing it.*





**_Volume essenziale definito da losanghe irregolari
rimarcate da un profilo nero.
Uno zoccolo in legno o finitura ottone ne permettono
l'inserimento e l'accostamento a più stili di arredo.**

*_An essential volume defined by irregular sections outlined by
a black piping. Base in wood or in brass finish to match it with
different styles.*

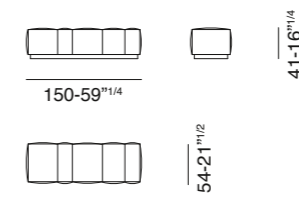

_IT Gli accessori Modern nascono e crescono da un progetto di successo, dal senso estetico equilibrato e ricco nei dettagli. Complementi dall'estetica universale, ricchi di giochi materici, questi accessori hanno una potenza nelle loro linee geometriche.

L'essenzialità delle dimensioni aeree del Comodino, della Toilette e della Consolle, accompagnate da una Panca, è resa ricercata nel gioco di insieme dei sofisticati materiali. La collezione di questi arredi-notte è stata ideata per farli dialogare tra di loro, ma anche pensata per farli vivere ciascuno in un ambiente proprio.

_EN *Modern complements come from a successful project characterized by aesthetic balance and abundance of details. They represent a universal aesthetic, rich in materials that emphasize geometric lines.*

The simple airy shape of the Night table, the Vanity, the Console and the Bench becomes even more refined thanks to the combination of sophisticated materials. This night collection was designed to make complements communicate with each other, but also to make them live in their own space.





_Gli elementi della collezione interpretano il gusto di un design essenziale e si inseriscono con la versatilità e la semplicità delle linee come protagonista sia nella zona notte che giorno.

_The elements of the collection represent the taste of an essential design and, thanks to the versatility and simplicity of their lines, they are main characters both in the night and in the living area.



_Panca
_Bench



_Comodino
_Night table

I piani in rovere tinto moka, noce Canaletto o legno laccato opaco o lucido, la testatina sulla consolle e sulla toilette in cuoio nelle varie coloriture, i dettagli in ottone lucido ne esaltano il fascino discreto e senza tempo.

A discreet and timeless charm is enhanced by the top in moka stained oak/Canaletto walnut/matt or glossy lacquered wood, by the back panel of the console and vanity in saddle leather in various colours and also by the details in polished brass.



_Toilette
_Vanity

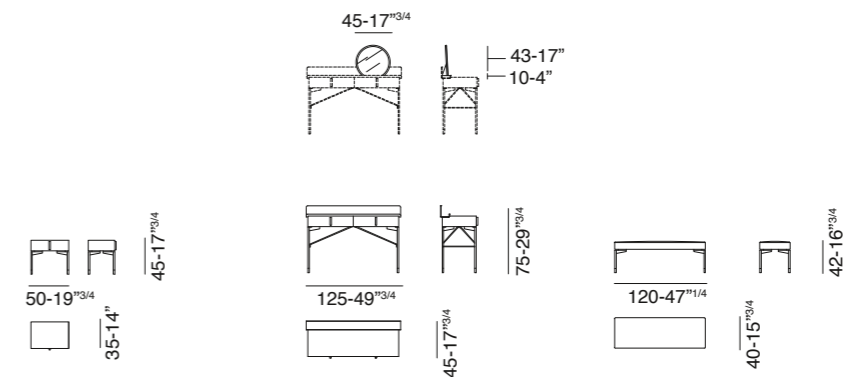

_IT Xenia: la funzione, la forma e lo stile raccontano lo spazio attorno al letto. Le curve e la solidità del legno: lavorazioni artigianali che esprimono valori in uno spazio intimo come la camera. Questi valori si ritrovano nelle spallette curve dei piani in marmo, dei comodini, della toilette e nelle geometrie pulite della Panca, pronti a trasformarsi per diventare il tuo spazio.

_EN Xenia: function, shape and style define the space around the bed. The handcrafted curved shapes of wood express great value in a private space as the bedroom. This value can also be found in the curved marble top of the Night table and the Vanity, as well as in the clean geometry of the Bench.





_Comodino dimensione piccola
_Small size night table



_Comodino dimensione media
_Medium size night table



_Comodino dimensione lunga
_Large size night table

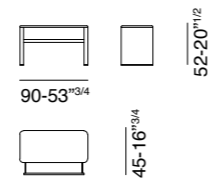
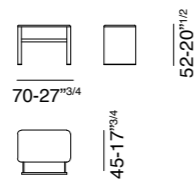
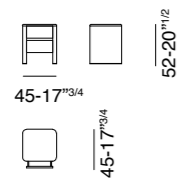



_Finitura in noce Canaletto o rovere tinto moka, piani di marmo nelle finiture di catalogo, dettagli con materiale pregiato in ottone lucido.

_Canaletto walnut or moka-stained oak frame, marble tops as per catalogue finishes, details in polished brass.



_Panca in noce Canaletto
_Bench in Canaletto walnut



_Toilette
_Vanity

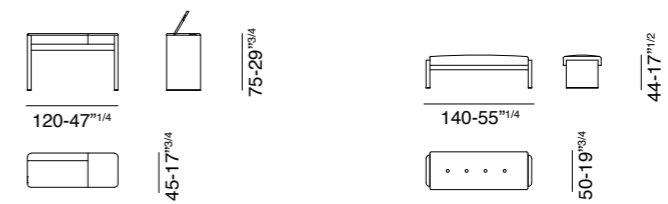

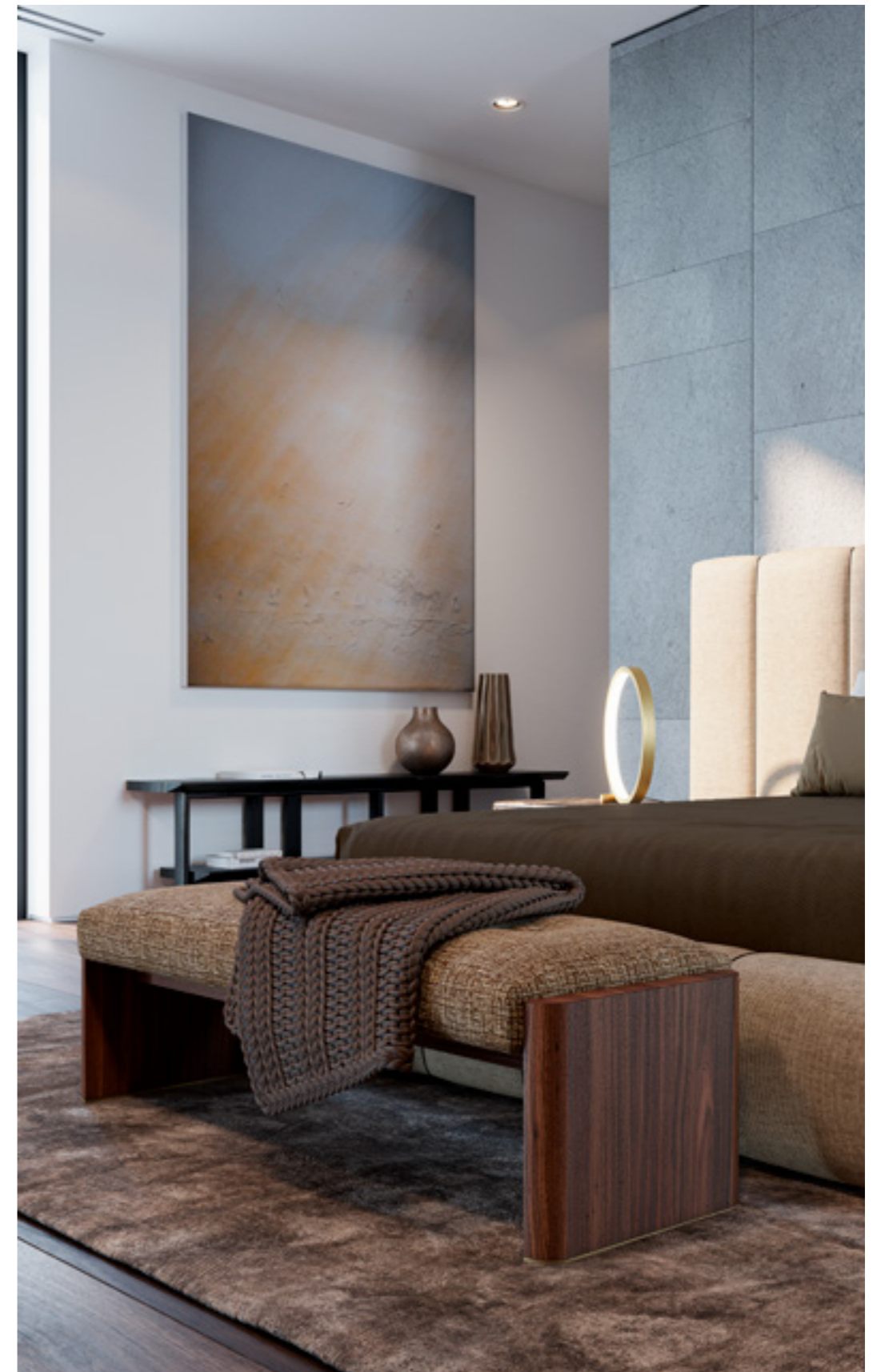

_Panca in noce Canaletto
_Bench in Canaletto walnut

_IT Il comodo Contraste si presenta con un'architettura semplice e tradizionale, dalla struttura in rovere tinto moka o noce Canaletto. Contraste reinterpreta la tradizione con rinnovata attenzione alla geometria e alla leggerezza delle linee.

_EN *Contraste night table has a simple and functional architecture. Frame available in moka stained oak or Canaletto walnut. Contraste reinterprets tradition with new attention to geometry and lightness.*





Contraste è razionalità.
Dall'estetica agile e funzionale grazie all'ampio cassetto, può essere inserito sia in un ambiente notte, sia giorno.

_Contraste is rationality. The wide drawer makes it practical and its design is suitable both for the night and the living area.



Comodino in noce Canaletto o rovere tinto moka
_Night table in Canaletto walnut or moka dyed oak

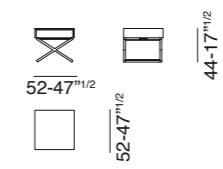

Vibieffe 85 srl

Via F.lli Bandiera 31/33, 20851 Lissone (MB) - Italy
Tel. +39 039 2455449 Fax. +39 039 2455430
contact@vibieffe.com www.vibieffe.com

ED- 07 /2023

Catalogo *Night Collection* | Art work *Altrodesign*

Vibieffe

SINCE 1968



