



IT_Descrizione prodotto

Divani, Divani componibili, Chaise longue, Pouf, Poltrona

Caratteristiche tecniche

Struttura base: Metallo verniciato.

Struttura schien/bracc: Massello di abete.

Molleggio: Nastri elastici unidirezionali ad alta portata.

Imbottitura base e schienale: Poliuretano espanso ricoperto in termofalda.

Imbottitura schienale: Poliuretano espanso ricoperto in termofalda.

Cuscini seduta: Inserto in poliuretano espanso avvolto da materassina in piuma.

Imbottitura bracciolo: Inserto in poliuretano espanso avvolto da materassina in piuma.

Piedi: Alluminio cromato.

Finitura: Cordolo tessuto.

Rivestimento: Rivestimento in tessuto o in pelle.

Rivestimento in tessuto completamente sfoderabile.

Accessorio: Comice in noce canaletto.

Note particolari

Nelle composizioni è necessario il disegno. All'ordine specificare colore cordolo.

EN_Product description

Sofas, Unit sofas, Chaise longue, Ottoman, Armchair

Technical features

Frame base: Painted metal.

Frame back/arm: Solid fir-wood.

Springing: High resistance unidirectional elastic bands.

Base and back padding: Polyurethane foam covered with heated bonded polyester fibre.

Seat cushions: Core in polyurethane foam covered with a feather layer.

Arm padding: Core in polyurethane foam covered with a feather layer.

Feet: Chromed aluminium.

Finishing: Fabric piping.

Cover: Fabric or leather cover.

Fabric cover completely removable.

Accessory: Base in Canaletto walnut.

Special notes

For compositions, please supply the drawing. Please specify piping colour on order.

Piedi / Feet



_metallo brunito
_burnished metal

Basamento / Base



_noce canaletto
_canaletto walnut

Vibieffe

SINCE 1968

contact@vibieffe.com www.vibieffe.com

470_FANCY

design: Gianluigi Landoni

- B - Espanso densità portante / Foam supporting density
- C - Espanso densità soft / Foam soft density
- F - Telaio in ferro / Iron frame
- L - Fusto in legno / Wooden frame
- P - Piuma / Feather
- R - Resinato / Heated bonded polyester fibre

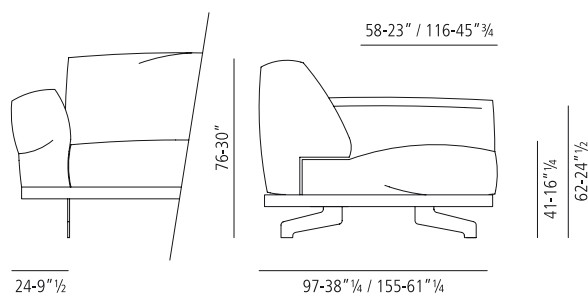
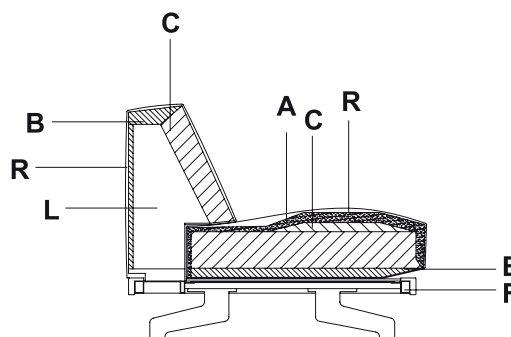

Vibieffe

SINCE 1968

contact@vibieffe.com www.vibieffe.com

470_FANCY

design: Gianluigi Landoni

cod. 470042

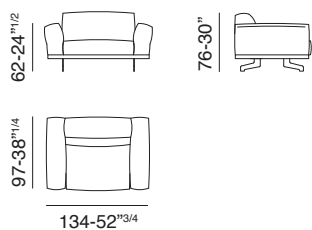

cod. 470020

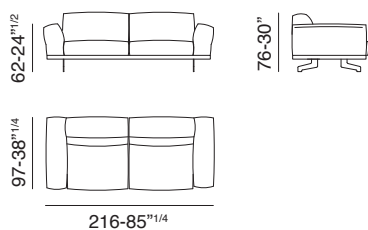

cod. 470021

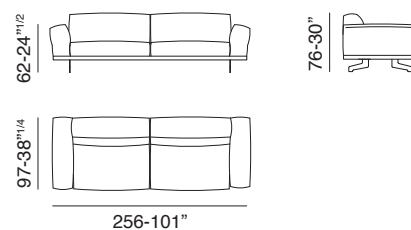

cod. 470022

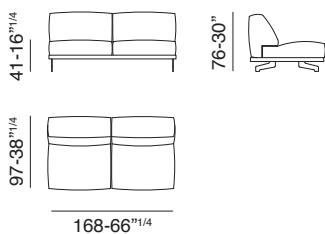

cod. 470024

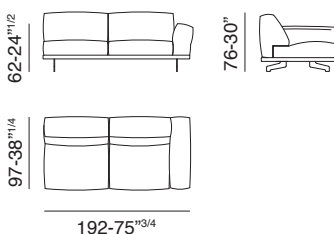

cod. 470025

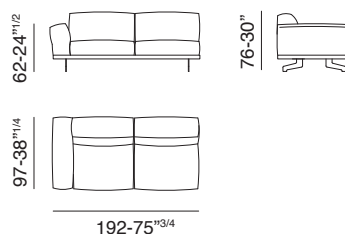

cod. 470023

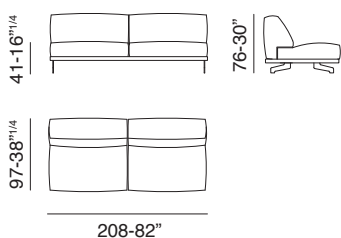

cod. 470026

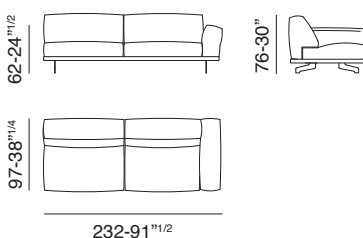

cod. 470027

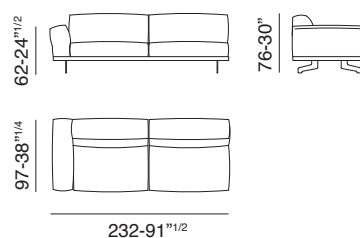

cod. 470033

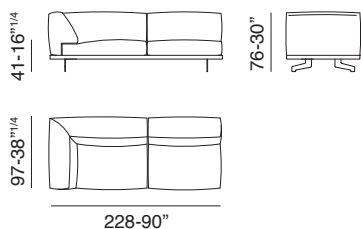

cod. 470032

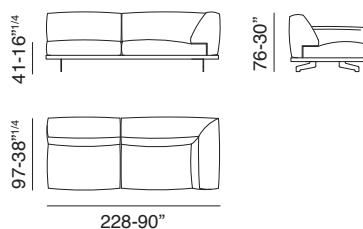

cod. 470034

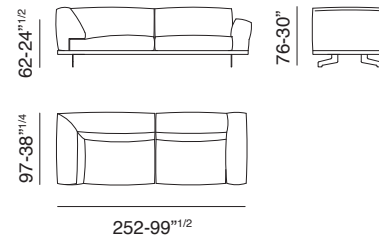

Vibieffe

SINCE 1968

contact@vibieffe.com www.vibieffe.com

470_FANCY

design: Gianluigi Landoni

cod. 470035

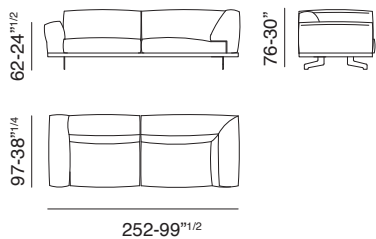

cod. 470037

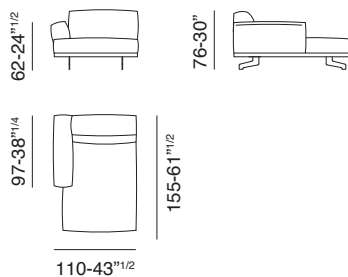

cod. 470036

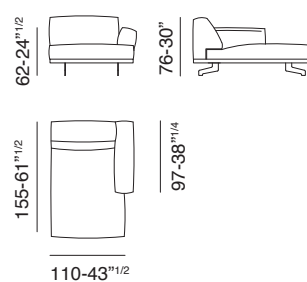

cod. 470043

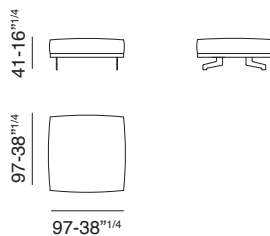

Vibieffe

SINCE 1968

contact@vibieffe.com www.vibieffe.com

470_FANCY

design: Gianluigi Landoni

